

PEL 112 PEL 113



Power & Energy Logger

Thank you for purchasing a **Power & Energy Logger PEL112** or **PEL113**.

To obtain the best service from your unit:

- **read** these operating instructions carefully,
- **comply** with the precautions for use.



WARNING, risk of DANGER! The operator must refer to these instructions whenever this danger symbol appears.



WARNING! Risk of electric shock. The voltage on the parts marked with this symbol may be dangerous.



Equipment protected by double insulation.



Earth.



USB socket.



Ethernet socket (RJ45).



SD Card.



Main power supply input.



Useful information or tip to read.



The product has been declared recyclable after analysis of its life cycle in accordance with the ISO14040 standard.



The CE marking indicates compliance with the European Low Voltage Directive (2014/35/EU), Electromagnetic Compatibility Directive (2014/30/EU), Radio Equipment Directive (2014/53/EU), and Restriction of Hazardous Substances Directive (RoHS, 2011/65/EU and 2015/863/EU).



The UKCA marking certifies that the product is compliant with the requirements that apply in the United Kingdom, in particular as regards Low-Voltage Safety, Electromagnetic Compatibility, and the Restriction of Hazardous Substances.



The rubbish bin with lines through it indicates that, in the European Union, the product must undergo selective disposal in compliance with Directive WEEE 2012/19/EU. This equipment must not be treated as household waste.

CONTENTS

1. GETTING STARTED	6
1.1. Delivery condition	6
1.2. Accessories	7
1.3. Spare parts	7
1.4. Charging the battery	7
2. PRODUCT FEATURES	8
2.1. Description.....	8
2.2. PEL112	9
2.3. PEL113	10
2.4. Back Panel Features	11
2.5. Terminal block.....	11
2.6. Installation of the colour-coded markers.....	12
2.7. Connection Features	12
2.8. Mounting.....	12
2.9. Key Functions	13
2.10. LCD Display (PEL113)	13
2.11. Memory card.....	14
2.12. LED.....	15
3. OPERATION	16
3.1. Turning the Instrument ON/OFF	16
3.2. Connection by USB or by Ethernet LAN link	16
3.3. Connection by Wi-Fi	17
3.4. Configuring the instrument	18
3.5. Information.....	21
4. USE	24
4.1. Distribution networks and connections	24
4.2. Recording	30
4.3. Measured-value display modes.....	30
5. SOFTWARE AND APPLICATION	50
5.1. PEL Transfer software	50
5.2. PEL application	51
6. SPECIFICATIONS	53
6.1. Reference Conditions	53
6.2. Electrical Specifications.....	53
6.3. Communication.....	65
6.4. Power Supply	65
6.5. Mechanical Specifications	65
6.6. Environmental characteristics.....	66
6.7. Safety Specifications	66
6.8. Electromagnetic Compatibility	66
6.9. Radio emission	66
6.10. Memory card.....	67
7. MAINTENANCE	68
7.1. Cleaning	68
7.2. Battery	68
7.3. Updating the software.....	68
8. WARRANTY	70
9. APPENDIX	71
9.1. Measurements.....	71
9.2. Measurement Formulas.....	73
9.3. Aggregation	74
9.4. Supported Electrical Networks	76
9.5. Quantity according to the distribution network.....	77
9.6. Glossary	81

Definition of measurement categories

- Measurement category IV (CAT IV) corresponds to measurements taken at the source of low-voltage installations.
Example: power feeders, meters and protection devices.
- Measurement category III (CAT III) corresponds to measurements on building installations.
Example: distribution panel, circuit-breakers, machines or fixed industrial devices.
- Measurement category II (CAT II) corresponds to measurements taken on circuits directly connected to low-voltage installations.
Example: power supply to domestic electrical appliances and portable tools.

Example to identify the locations of measurement categories

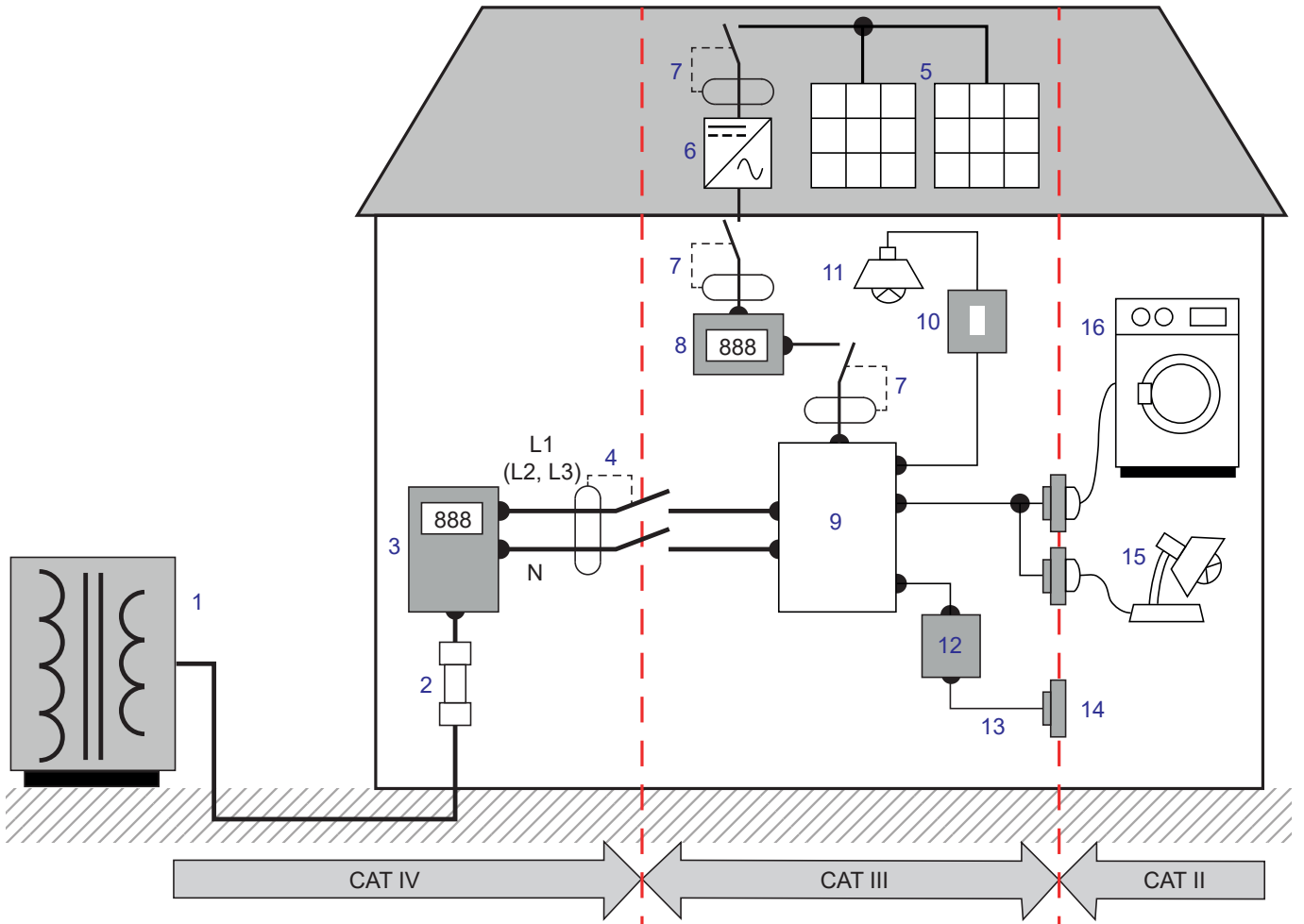

- | | |
|--|---|
| 1 Low-voltage supply source over or under ground | 9 Distribution board |
| 2 Service fuse | 10 Light switch |
| 3 Tariff meter | 11 Lighting |
| 4 Mains circuit breaker or isolator switch * | 12 Junction box |
| 5 Photovoltaic panel | 13 Socket wiring |
| 6 DC to AC inverter | 14 Socket outlets |
| 7 Circuit breaker or isolator switch | 15 Plug-in lamps |
| 8 Generation meter | 16 Household appliances, portable tools |

* : The mains circuit breaker or isolator switch may be installed by the service provider. If not, the demarcation point between CAT IV and CAT III is the first isolating switch in the distribution board.

PRECAUTIONS FOR USE

This instrument complies with safety standard IEC/EN 61010-2-030 and the leads comply with IEC/EN 61010-031, for voltages of 1000 V in measurement category III or 600 V in measurement category IV.

Failure to observe the safety instructions may result in electric shock, fire, explosion, and destruction of the instrument and of the installations.

- The operator and/or the responsible authority must carefully read and clearly understand the various precautions to be taken in use. Sound knowledge and a keen awareness of electrical hazards are essential when using this instrument.
- Use only the supplied or specified accessories (voltage leads, current sensors, mains adaptor, etc.).
 - When assembling an instrument with leads, crocodile clips or mains adaptor, the nominal voltage for a single measurement category is the lowest of the nominal voltages assigned to the individual components.
 - When connecting a current sensor to a measuring instrument, account must be taken of any potential feedback of voltage from the measuring instrument to the current sensor and therefore of the common mode voltage and acceptable measurement category at the current sensor secondary.
- Before each use, check that the leads, enclosures, and accessories are in perfect condition. Any lead, sensor or accessory on which the insulation is damaged (even partially) must be repaired or scrapped.
- Do not use the instrument on networks of which the voltage or category exceeds those mentioned.
- Do not use the instrument if it seems to be damaged, incomplete, or poorly closed.
- Use only the AC power adapter supplied by the manufacturer.
- When removing and replacing the SD-Card, make sure that the device is disconnected and switched off.
- We recommend using Personal Protection Equipment where required.
- Keep your hands away from unused terminals.
- If the instrument is wet, dry it before connecting it.
- All troubleshooting and metrological checks must be performed by competent and accredited personnel.

1. GETTING STARTED

1.1. DELIVERY CONDITION

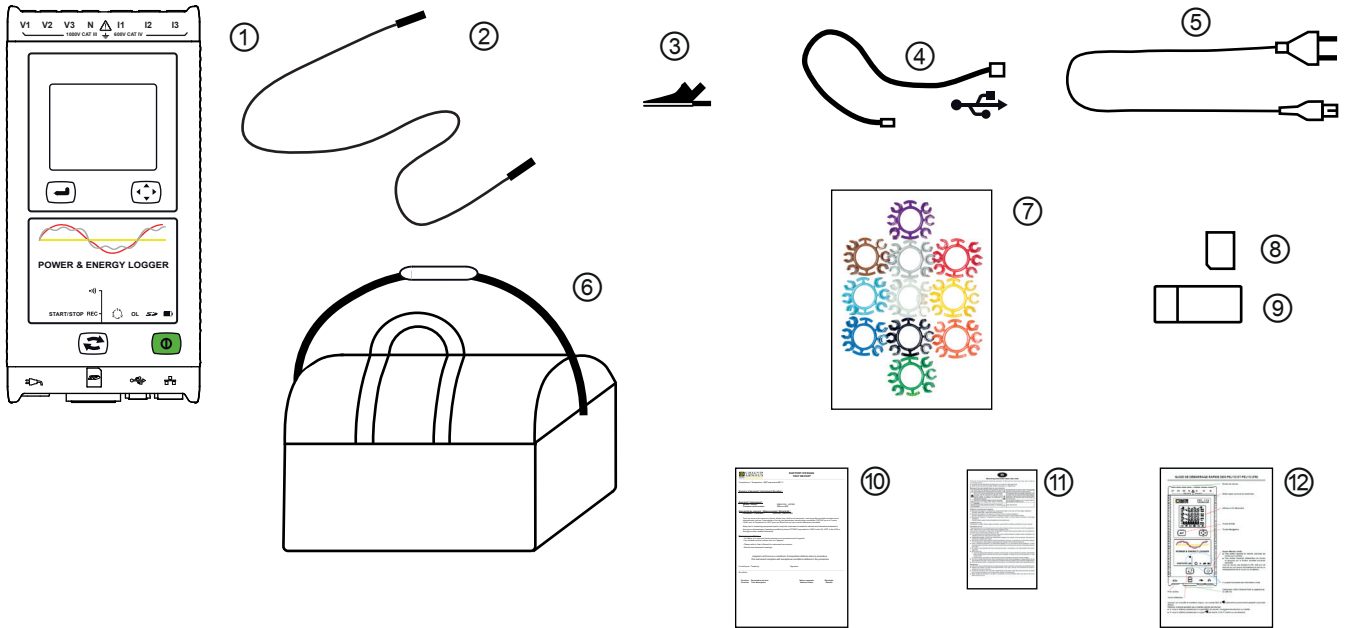

Figure 1

No.	Designation	Quantity
①	PEL112 or PEL113 (depends on the model).	1
②	Black safety leads, 3m, banana-banana, straight-straight attached by a Velcro tie.	4
③	Black crocodile clips.	4
④	Type A-B USB cord 1.5m.	1
⑤	Mains cord 1.5m.	1
⑥	Carrying bag.	1
⑦	Set of inserts and rings for marking the leads and current sensors according to phase.	12
⑧	8 GB SD-card (in the instrument).	1
⑨	USB SD-Card adapter.	1
⑩	Test report.	1
⑪	Multilingual safety data sheet.	1
⑫	Quick start guide.	14

Table 1

1.2. ACCESSORIES

- MiniFlex MA194 250 mm
- MiniFlex MA194 350 mm
- MiniFlex MA194 1000 mm
- MN93 clamp
- MN93A clamp
- MINI94 clamp
- C193 clamp
- AmpFlex® A193 450 mm
- AmpFlex® A193 800 mm
- PAC93 clamp
- E94 clamp
- J93 clamp
- 5 A adapter unit (three-phase)
- 5 A adapter Essailec®
- Magnetic test probes
- Dataview Software



The weight exerted by the measuring leads may cause the magnetic test probes to come loose. We advise you to support them by securing them to the electrical installation. This can be, for example, by a magnetic cable clamp or cable reel.

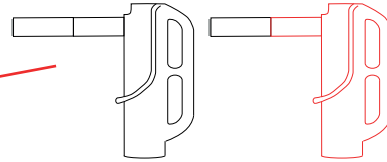

1.3. SPARE PARTS

- USB-A USB-B cord
- Mains cord 1.5m
- Cable reel



- No. 23 carrying bag
- Set of 4 black banana-banana straight-straight safety cables, 4 black crocodile clips and 12 inserts and rings to identify phases, voltage leads and current sensors

For accessories and spares, visit our web site:

www.chauvin-arnoux.com

1.4. CHARGING THE BATTERY

Before the first use, start by fully charging the battery at temperatures between 0 and 40°C.

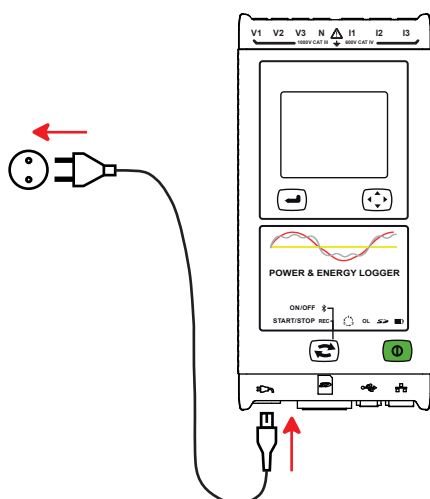

Figure 2

Connect the mains cord to the device and to mains.

The device turns on.

The  LED lights; it will go out only when the battery is fully charged.



Charging a discharged battery takes approximately 5 hours.



After prolonged storage, the battery may be completely discharged. If so, the  LED blinks twice per second. In this case, at least 5 charge/discharge cycles will be necessary for your battery to recover 95% of its capacity.

2. PRODUCT FEATURES

2.1. DESCRIPTION

PEL: Power & Energy Logger

The PEL112 and PEL113 are simple-to-use single-, dual-, and three-phase (Y, Δ) Power & Energy Loggers.

The PEL offers all necessary functions for Power/Energy data logging for most 50 Hz, 60 Hz, 400 Hz and DC distribution systems worldwide, with many connection possibilities. The PEL is designed to work in 1000 V CAT III and 600 V CAT IV environments.

The PEL is compact and can be incorporated in many distribution panels.

The PEL provides the following measurements and calculations:

- Direct measurements of voltages up to 1000 V CAT III and 600 V CAT IV
- Direct measurements of current from 5 mA up to 12 000 A depending on the current sensor
- Power measurements: active (W), reactive (var) and apparent (VA)
- Measurements of the fundamental active power.
- Energy measurements: active (source and load (Wh)), reactive 4 quadrants (varh) and apparent (VAh)
- Power Factor (PF), $\cos \phi$, and $\tan \Phi$
- Crest Factor
- Total Harmonic Distortion (THD) for voltages and currents
- Harmonics from the fundamental signal up to the 50th order for 50/60 Hz voltages and currents
- Harmonics from the fundamental signal up to the 7th order for 400 Hz voltages and currents
- Frequency measurements
- RMS and DC measurements all phases simultaneously
- Bright white triple LCD display with white backlighting for the PEL113 (3 phases shown simultaneously)
- Storage of measured and calculated values on an SD, SDHC ou SDXC-Card
- Automatic recognition of the different types of current sensors and power supply of E94 clamps
- Configuration of current and voltage ratios with external sensors
- Supports 17 types of connections or electrical distribution systems
- USB, LAN, and Wi-Fi communication
- IRD server (DataViewSync™) to communicate using private IP addresses.
- PEL Transfer software for data recovery, configuration and real-time communication with a PC
- Android application to communicate in real time and configure the PEL from a smartphone or a tablet.
- 32 programmable alarms on the measurements.
- Sending of periodic reports by email.

2.2. PEL112

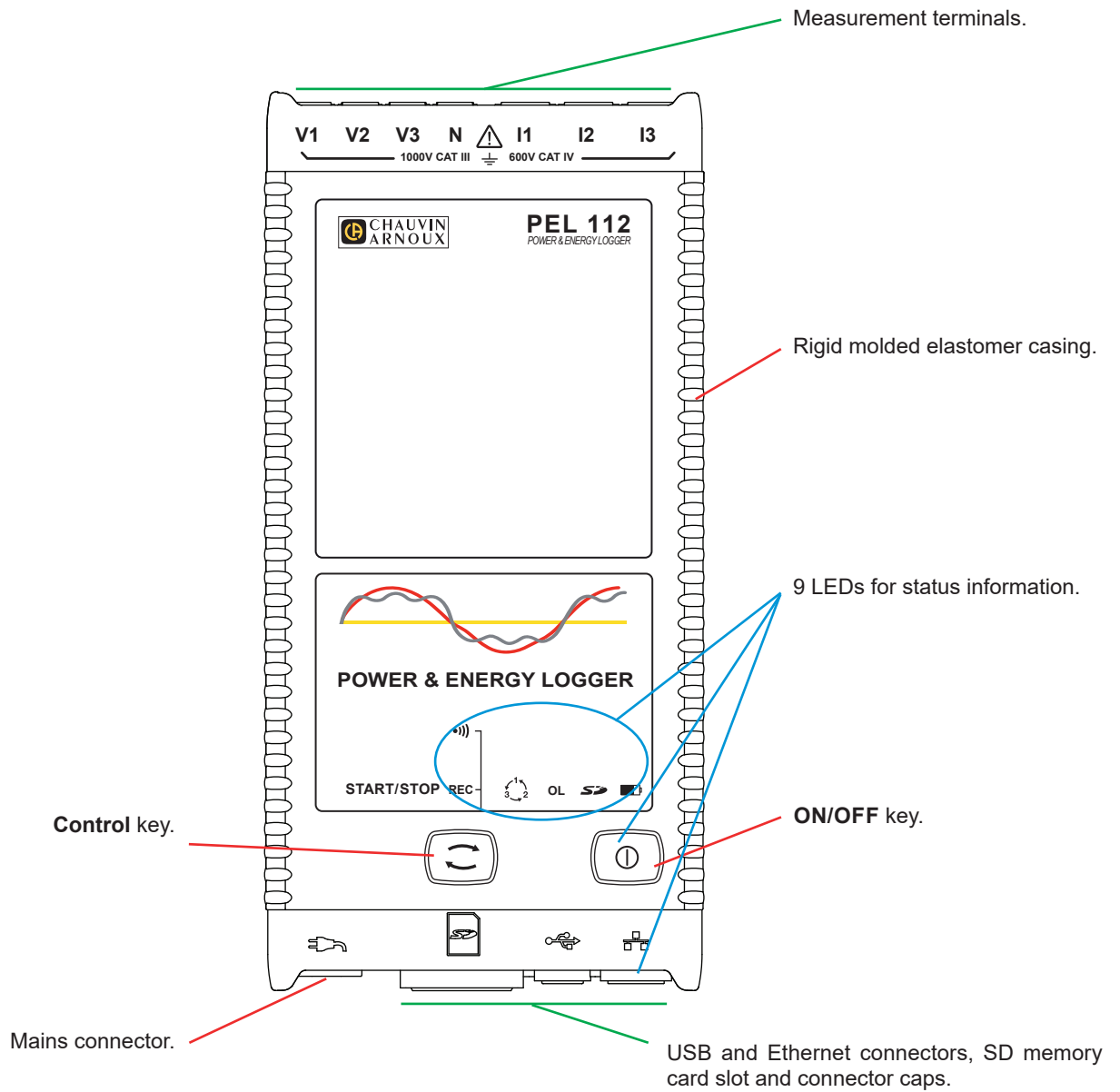

Figure 3

2.3. PEL113

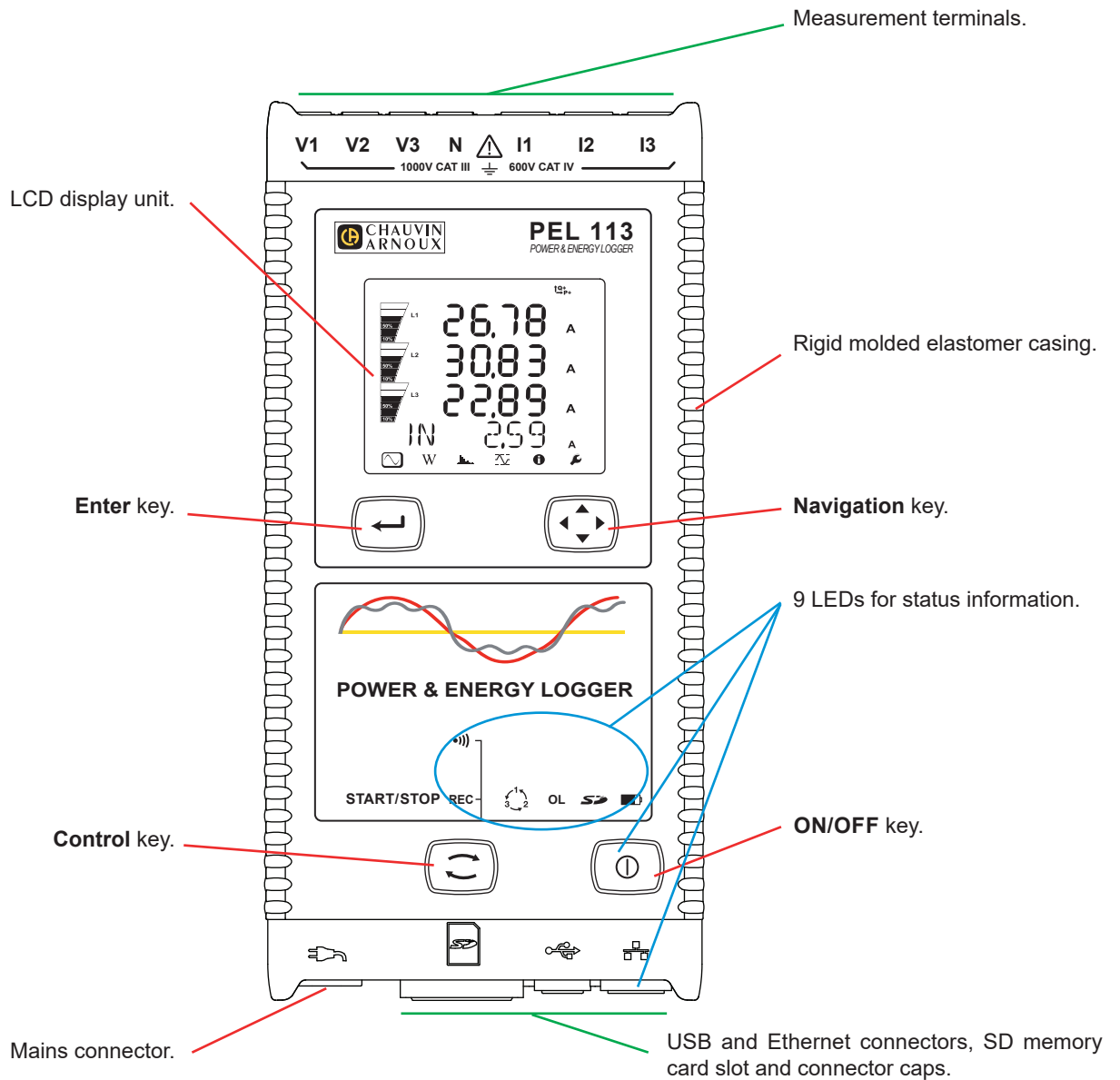

Figure 4

2.4. BACK PANEL FEATURES

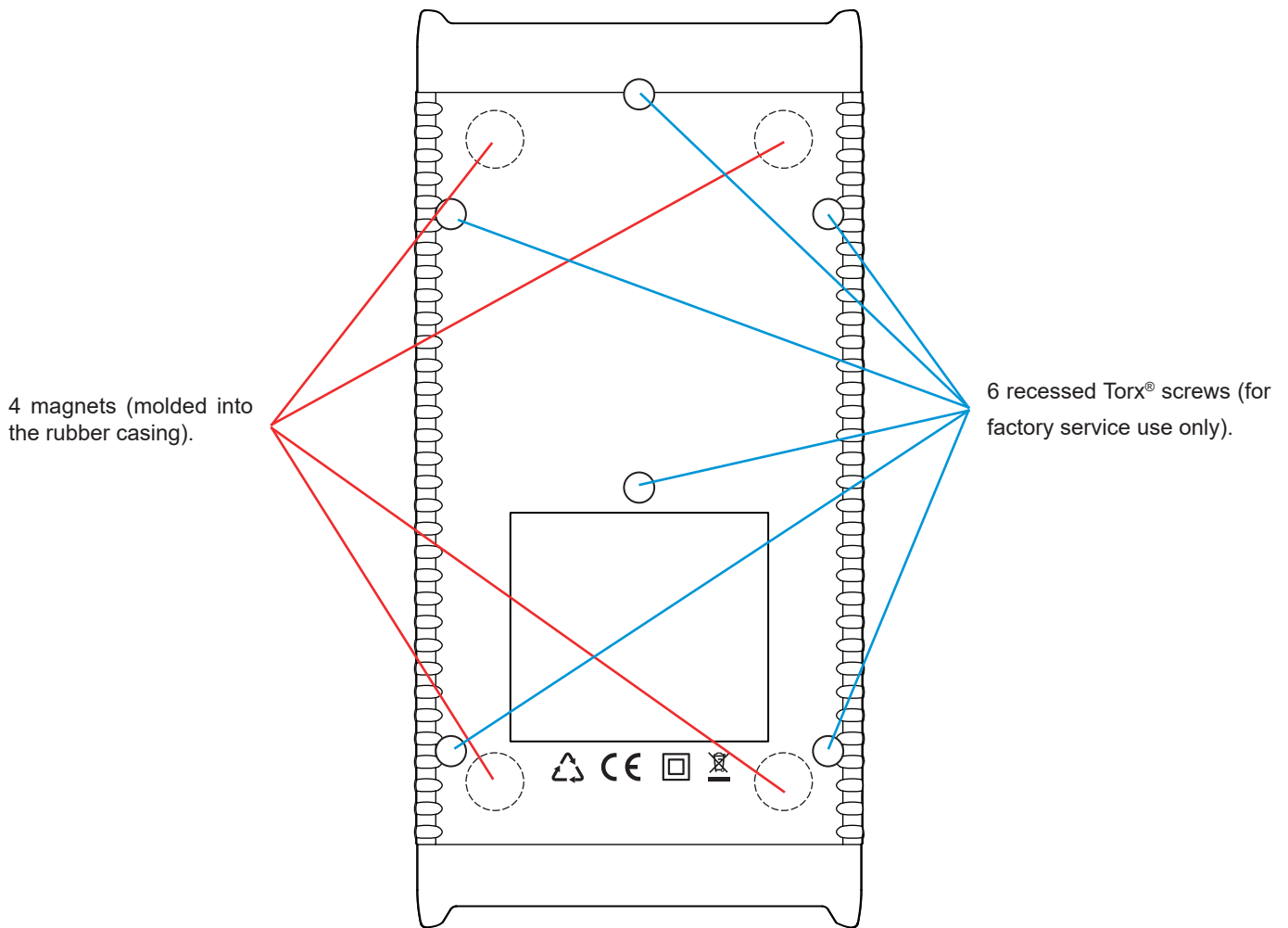

Figure 5

2.5. TERMINAL BLOCK

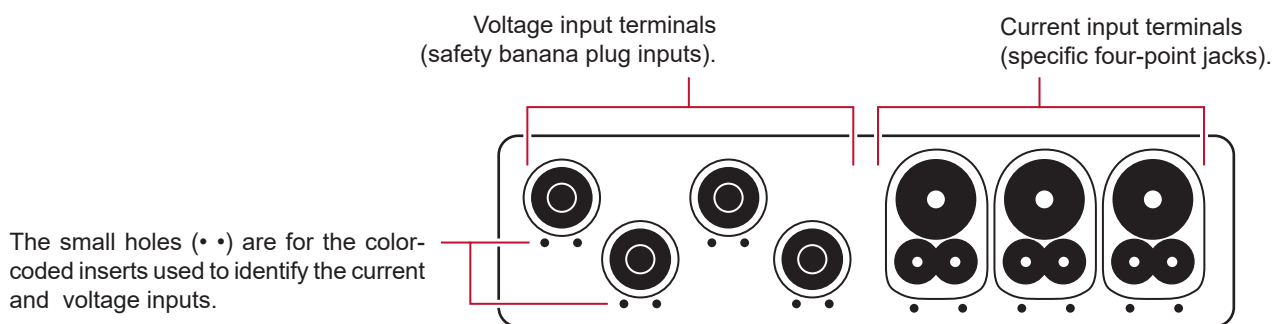

Figure 6



Before connecting a current sensor, refer to its directions for use.

2.6. INSTALLATION OF THE COLOUR-CODED MARKERS

For multiple-phase measurements, start by marking the accessories and terminals with the colour-coded ID markers supplied with the device; a different colour for each terminal.

- Detach the appropriate inserts and place them in the holes under the terminals (larger inserts for current terminals, smaller inserts for voltage terminals).
- Clip rings of the same colour to the ends of the lead you will be connecting to the terminal.

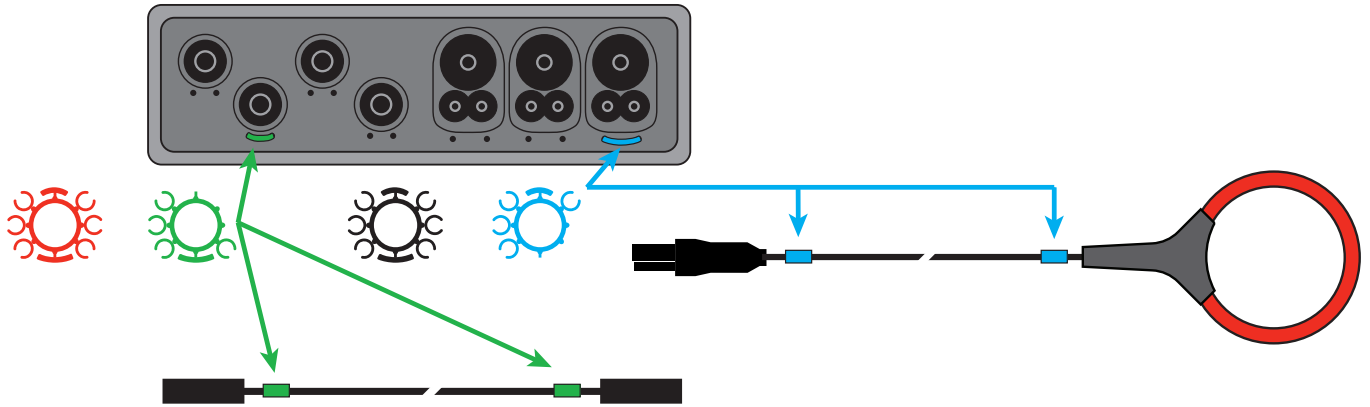

Figure 7

2.7. CONNECTION FEATURES

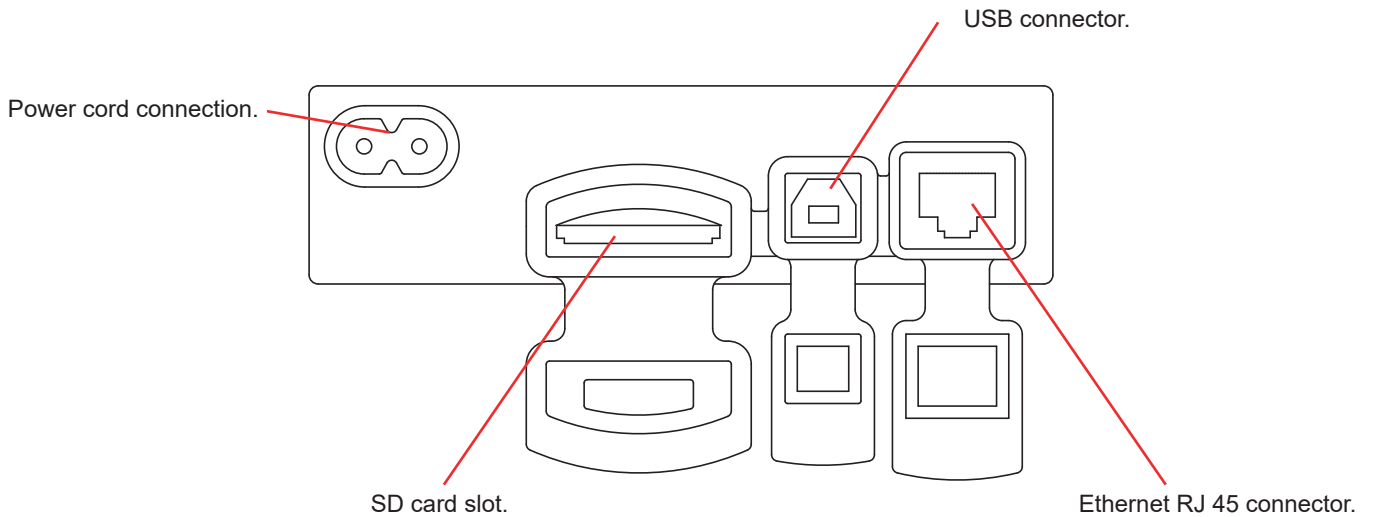

Figure 8

2.8. MOUNTING

As a logger, the PEL is designed to be installed for an extended period in a utility room.

The PEL should be placed in a well-ventilated room. Temperature should not exceed the values specified in § 6.6.

The PEL can be mounted on a flat ferromagnetic vertical surface using the built-in magnets.



The strong magnetic field can damage your hard drives or medical devices.

2.9. KEY FUNCTIONS





Key	Description
	ON/OFF key Turns the instrument ON or OFF. Note: The instrument cannot be turned OFF while connected to an AC outlet or if a recording is in progress.
	Control key: A long press activates or deactivates the Wi-Fi link and starts or stops recording.
	Enter key (PEL113) In the configuration mode, serves to select a parameter to be modified. In the measurement and power display modes, serves to display the phase angles and the partial energies.
	Navigation key (PEL113) These are used to browse the data displayed on the LCD screen.

Table 2

2.10. LCD DISPLAY (PEL113)

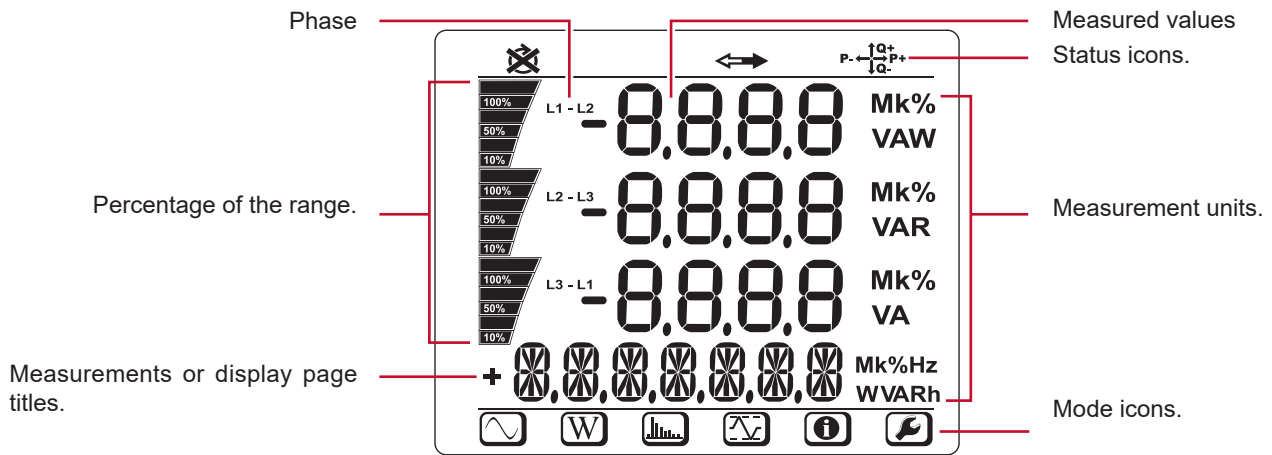

Figure 9

The top and bottom bars indicate the following:

Icon	Description
	Phase Sequence reversal or missing phase indicator (displayed only in Measurement Mode, see explanations below)
	Data are available for recording (non-display indicates possible internal problem)
	Indication of the power quadrant (see §9.1)
	Measurement Mode (Real Time values) (see §4.3.1)
	Power and Energy Mode (see §4.3.2)
	Harmonics Mode (see §4.3.3)
	Max Mode (see §4.3.4)
	Information Mode (see §3.5)
	Set-up mode (see §3.4)

Table 3

Phase order

The phase order icon is displayed on the LCD only when Measurement Mode is selected.

The phase order is determined every second. If the phase order is incorrect, the  symbol is displayed on the LCD display.

- Phase order for voltage channels only is displayed when voltages are displayed on measurement screen.
- Phase order for current channels only is displayed when currents are displayed on measurement screen.
- Phase order for voltage and current channels is displayed when the other screens are displayed.
- The source and load must be parameterized using PEL Transfer to define the direction of the energy (imported or exported).

2.11. MEMORY CARD

The PEL accepts SD, SDHC and SDXC cards, FAT32 formatted, up to a capacity of 32 GB.

The PEL is delivered with a formatted SD card. If you want to install a new SD card:

- Open the elastomer cap marked .
- Press on the SD card in the device, then withdraw it.



Warning: do not withdraw the SD card if there is a recording session in progress

- Check that the new SD card is not locked.
- It is best to format the SD card using the PEL Transfer software; it can also be formatted by a PC.
- Insert the new card and push it home.
- Put the protective elastomer cap back in place.

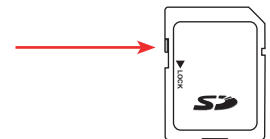

2.12. LED







LED & Colour	Description
REC Red LED	Recording Status Indicator off: no recording programmed or in progress Indicator blinking: recording programmed Indicator on: recording in progress
 Green LED	Wi-Fi LED off: Wi-Fi link off (disabled) LED on: Wi-Fi link enabled but not transmitting LED blinking: Wi-Fi link enabled and transmitting
 Red LED	Phase order OFF: the order of phase rotation is correct. LED blinking: the order of phase rotation is incorrect. See § 6.2.3.4.
OL Red LED	Overload OFF: No overload on the inputs LED blinking: At least one input is overloaded, indicates that a lead is either misconnected or missing
 Red/green LED	SD-Card Green LED ON: SD-Card is OK LED blinking red: the SD card is being initialized LED blinking alternately red and green: the SD card is full LED blinking light green: the SD card will be full before the end of the current recording session Red LED ON: SD-Card is missing or locked
 Orange/red LED	Battery LED OFF: Battery full Orange LED ON: Battery is charging Orange LED blinking: Battery is recovering from a full discharge Red LED blinking: Low battery (and no power supply)
 Green LED <i>in ON/OFF key</i>	ON/OFF LED ON: External power supply present LED OFF: No external power supply
 Green LED <i>embedded in the connector</i>	Ethernet LED OFF: No activity LED blinks: Activity
 Yellow LED <i>embedded in the connector</i>	Ethernet LED OFF: The stack failed to initialize or the Ethernet controller failed to initialize Slow blinking (once a second): The stack initialized properly Rapid blinking (10 times per second): The Ethernet controller initialized properly Blinks twice, then pause: DHCP Error LED ON: Network initialized and ready for use

Table 4

3. OPERATION

The PEL must be configured before any recording. The various steps in this configuration are:

- Set up the USB link, the Ethernet link or the Wi-Fi link.
- Choose the connection according to the type of distribution network.
- Connect the current sensors.
- Define the nominal primary and secondary voltages if necessary.
- Define the nominal primary current and the nominal primary current of the neutral if necessary.
- Choose the aggregation period.

This configuration is done in the Configuration mode (see § 3.4) or using the PEL Transfer software (see § 5). To forestall accidental modifications, the PEL cannot be configured while recording or if a recording session has been programmed.

3.1. TURNING THE INSTRUMENT ON/OFF

3.1.1. TURNING ON

- Connect the PEL to a power outlet with the AC power cord and the PEL will turn ON automatically. If not, press the **ON/OFF** key for more than 2 seconds.
- The green LED under the **ON/OFF** key turns ON when the PEL is connected to a live supply source.



The battery automatically begins recharging when the PEL is connected to a live power outlet. Battery life is approximately 1/2 hour when the battery is fully charged, enough to cover brief power outages.

3.1.2. TURNING THE PEL OFF

You cannot turn the PEL OFF if it is connected to a power source or if a recording is in progress (or pending). This is a precaution to ensure that the PEL is not accidentally turned OFF when recording and to ensure that the PEL turns on when the power supply is turned back on after an outage.

To turn the PEL OFF:

- Unplug the cord from the power outlet.
- Press the **ON/OFF** key for more than 2 seconds, until all LEDs turn on. Then release the **ON/OFF** key.
- All LEDs and the display will turn off as the PEL powers down.

3.1.3. STANBY MODE

With no user presence evident, the instrument goes into standby after three minutes (this duration can be programmed at 3, 10 or 15 minutes via the PEL Transfer application software). It continues to make measurements but they are no longer displayed. Standby mode can be inhibited.

The screen's white backlight comes on at start-up. It turns off after 3 minutes. It turns on again when a key is pressed.

3.2. CONNECTION BY USB OR BY ETHERNET LAN LINK

The USB and Ethernet links can be used to configure the instrument using PEL Transfer software, to display the measurements, and to upload records to the PC.

- Withdraw the elastomer cap that protects the connector.
- Connect the USB cable provided or an Ethernet cable (not provided) between the instrument and the PC.



Before connecting the USB cable, install the drivers supplied with the PEL Transfer software (see § 5).

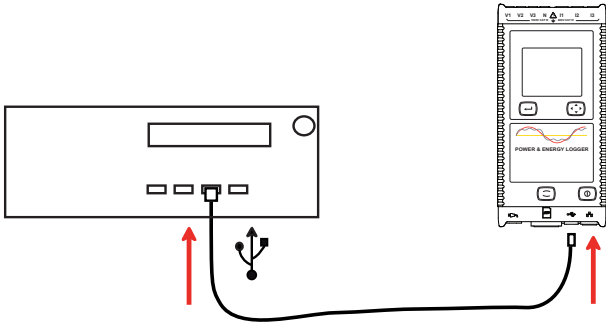

Figure 10

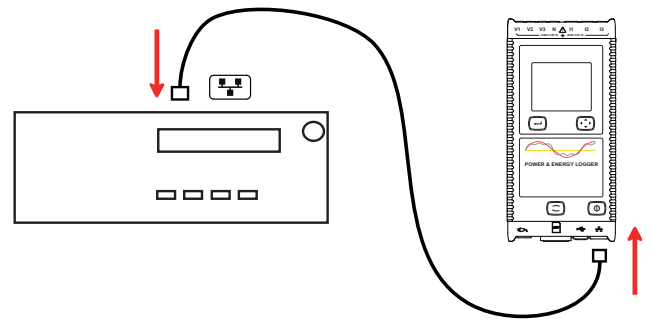

Figure 11

Then, whichever link was chosen, open the PEL Transfer software (see § 5) to connect the instrument to the PC.



Connecting the USB or Ethernet cable does not power up the instrument or charge the battery.

For the Ethernet LAN link, the PEL has an IP address.

When you configure the instrument with the PEL Transfer software, if the “Activate DHCP” (dynamic IP address) box is checked, the instrument sends a request to the network’s DHCP server to obtain an IP address automatically.

The Internet protocol used is UDP or TCP. The port used by default is 3041. It can be modified in PEL Transfer so as to enable connections between the PC and several instruments behind a router.

The auto IP address mode is also available when the DHCP is selected and the DHCP server has not been detected within 60 seconds. The PEL will use 169.254.0.100 as default address. This auto IP address mode is compatible with APIPA.





A crossed cable may be necessary.



You can change the network parameters while connected via an Ethernet LAN link, but once the network parameters have been changed, you will lose connection. It is better to use a USB connection for this.

3.3. CONNECTION BY WI-FI

This link can be used to configure the instrument using the PEL Transfer software, to view the measurements, and to upload the recordings to a PC, a smartphone, or a tablet.

- Press the **Selection**  key and hold it down. The **REC** and  indicators light in turn for 3 seconds each.
- Release the **Selection**  key while the desired function is lit.
 - If you release it while the **REC** indicator is lit, recording starts or stops.
 - If you release it while the  indicator is lit, Wi-Fi is enabled or disabled.



When you press the **Select** button, if the **REC** indicator is blinking, the **Select** button is locked. The PEL Transfer software must be used to unlock it.

The data transmitted by the device can:

- go directly to a PC connected to it by Wi-Fi,
- pass via an IRD server (DataViewSync™) hosted by Chauvin Arnoux. To receive them on your PC, you must enable the IRD server (DataViewSync™) in PEL Transfer and specify whether the link is via Ethernet or Wi-Fi.

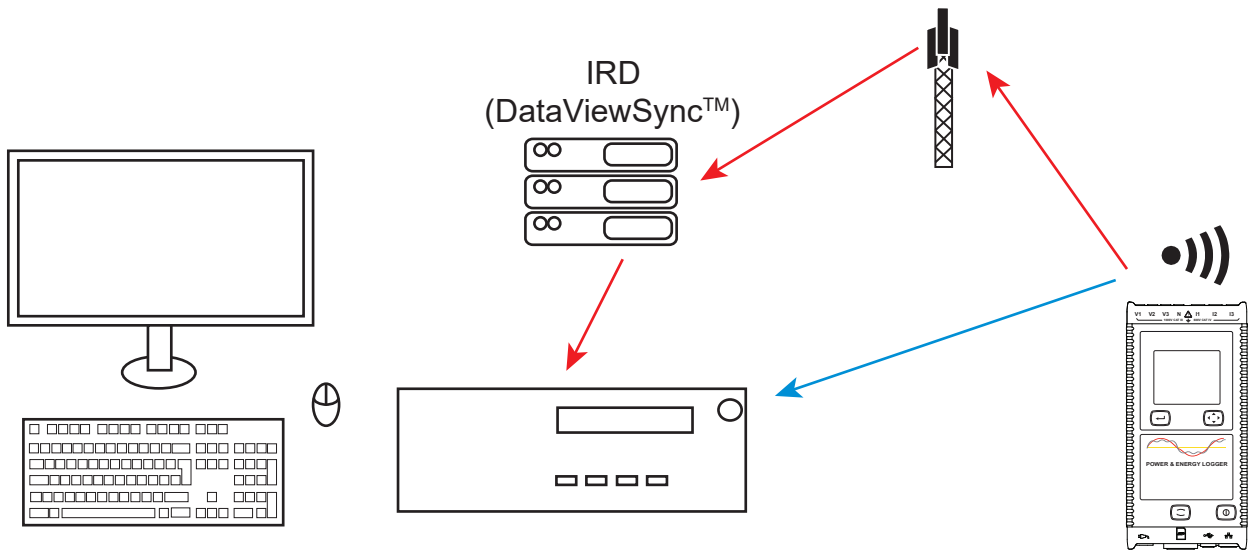



Figure 12

3.4. CONFIGURING THE INSTRUMENT

It is possible to configure some main functions directly on the instrument. For a complete configuration, use the PEL Transfer software (see § 5).

To enter the Configuration via the instrument mode, press the ◀ or ▶ key until the  symbol is selected. The following screen is displayed:

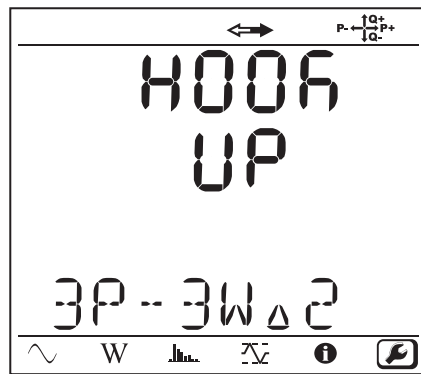



Figure 13



If the PEL is already being configured via the PEL Transfer software, it is impossible to enter the Configuration mode in the instrument. In this case, when there is an attempt to configure it, the instrument displays **LOCK**.

After 3 minutes without pressing the **Enter** or **Navigation** key, the display returns to the measurement screen.

3.4.1. TYPE OF NETWORK

To change the network, press the **Enter**  key. The name of the network blinks. Use the **▲** and **▼** keys to choose another network from among those in the list below.

Designation	Network
1P-2W	Single-phase, 2-wire
1P-3W	Single-phase, 3-wire
3P-3WΔ2	Three-phase, 3-wire Δ (2 current sensors)
3P-3WΔ3	Three-phase, 3-wire Δ (3 current sensors)
3P-3WΔb	Three-phase, 3-wire Δ, balanced
3P-4WY	Three-phase, 4-wire, wye
3P-4WYb	Three-phase, 4-wire, wye, balanced (voltage measurement, fixed)
3P-4WY2	Three-phase, 4-wire, wye 2½
3P-4WΔ	Three-phase, 4-wire Δ
3P-3WY2	Three-phase, 3-wire, wye (2 current sensors)
3P-3WY3	Three-phase, 3-wire, wye (3 current sensors)
3P-3WO2	Three-phase, 3-wire open Δ (2 current sensors)
3P-3WO3	Three-phase, 3-wire open Δ (3 current sensors)
3P-4WO	Three-phase, 4-wire, open Δ
dC-2W	DC 2-wire
dC-3W	DC 3-wire
dC-4W	DC 4-wire

Table 5

Validate your choice by pressing the **Enter**  key.

3.4.2. CURRENT SENSORS

Connect the current sensors to the instrument.

The current sensors are automatically detected by the instrument. It looks at the I1 terminal. If there is nothing, it looks at the I2 terminal, or the I3 terminal.

Once the sensors have been recognized, the instrument displays their transformation ratio.



The current sensors must all be the same, except for the neutral current sensor, which may be different. Otherwise, only the type of sensor connected to I1 will be used on the instrument.

3.4.3. NOMINAL PRIMARY VOLTAGE

Press the ▼ key to go to the next screen.

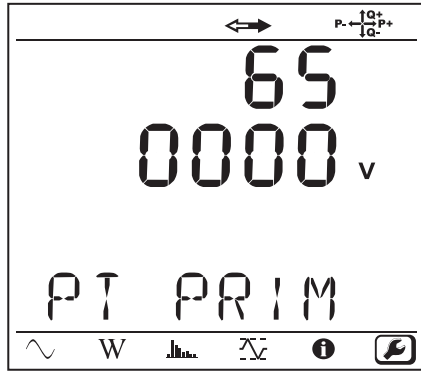





Figure 14

To change the nominal primary voltage, press the **Enter**  key. Use the ▲, ▼, ◀ and ▶ keys to choose the voltage, between 50 and 650,000 V. Then validate by pressing the **Enter**  key.

3.4.4. NOMINAL SECONDARY VOLTAGE

Press the ▼ key to go to the next screen.

To change the nominal secondary voltage, press the **Enter**  key. Use the ▲, ▼, ◀ and ▶ keys to choose the voltage, between 50 and 1,000 V. Then validate by pressing the **Enter**  key.

3.4.5. NOMINAL PRIMARY CURRENT

Press the ▼ key to go to the next screen.

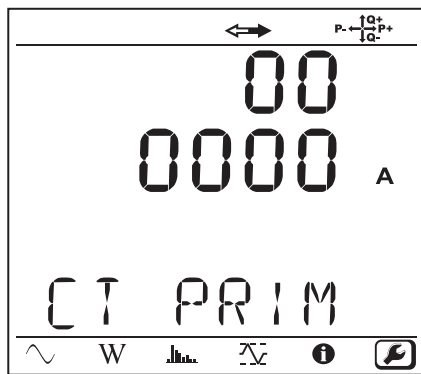



Figure 15

Depending on the type of current sensor, MiniFlex/AmpFlex®, MN clamp, or adapter unit, enter the nominal primary current. To do this, press the **Enter**  key. Use the ▲, ▼, ◀ and ▶ keys to choose the current.

- AmpFlex® A193 and MiniFlex MA194: 100, 400, 2,000 or 10,000A (depending on the sensor)
- PAC93 clamp and C193 clamp: automatic at 1,000A
- MN93A clamp, 5A range, 5A Adapter: 5 to 25,000A
- MN93A clamp, 100A range: automatic at 100A
- MN93 clamp and MINI94 clamp: automatic at 200A
- E94 clamp: 10 or 100A
- J93 clamp: automatic at 3,500 A
- 5 A adapter box: 5 to 25,000A

Validate the value by pressing the **Enter**  key.

3.4.6. AGGREGATION PERIOD

Press the ▼ key to go to the next screen.

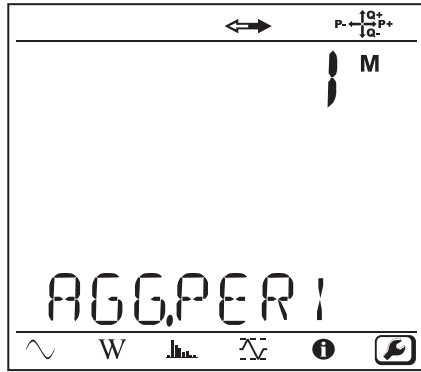



Figure 16

To change the aggregation period, press the **Enter**  key, then use the ▲ and ▼ keys to choose the value (1 to 6, 10, 12, 15, 20, 30, or 60 minutes).

Validate by pressing the **Enter**  key.

3.5. INFORMATION

To enter the Information mode, press the ◀ or ▶ key until the  symbol is selected.

Use the ▲ and ▼ keys to scroll the information of the instrument:

- Type of network

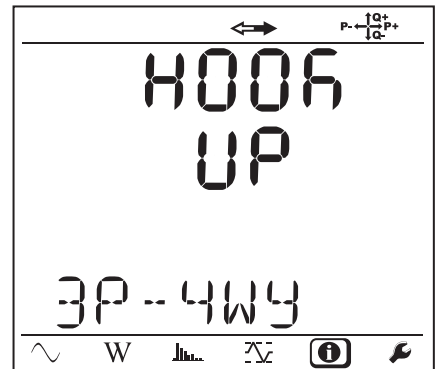

- Nominal primary voltage

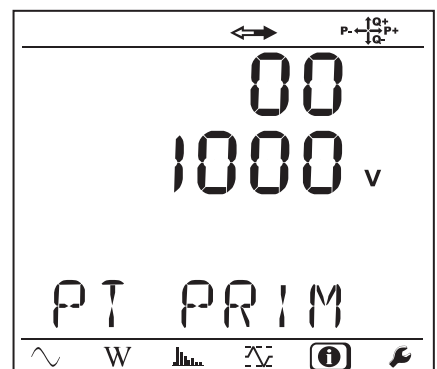

- Nominal secondary voltage

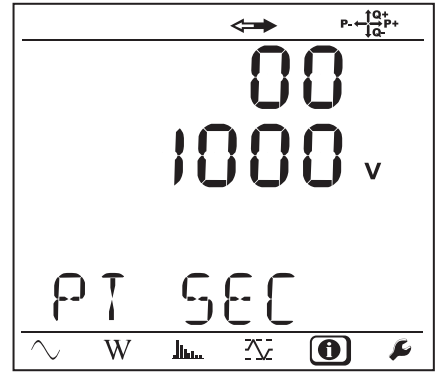

- Nominal primary current

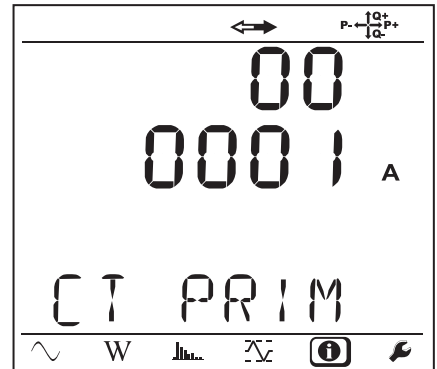

- Aggregation period

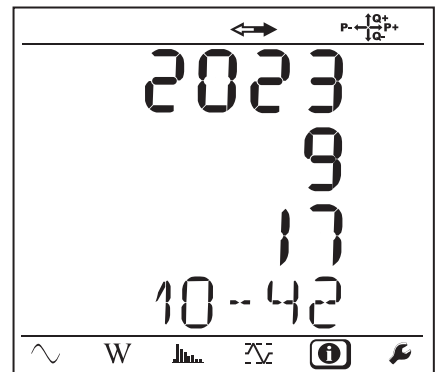

- Date and time

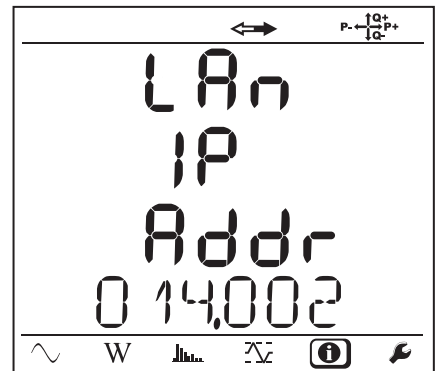

- IP address (scrolling)

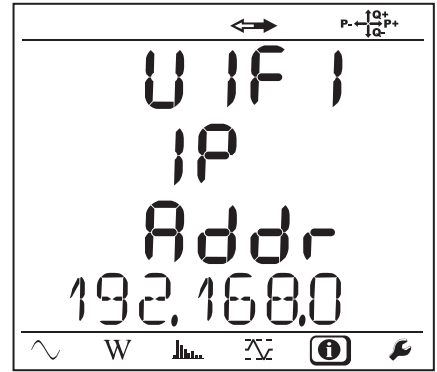

- Wi-Fi address (scrolling)

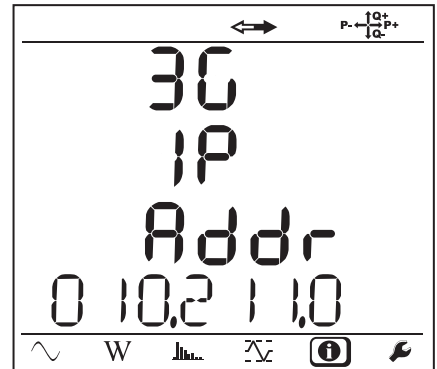

- Software version
 - 1st number = software version of the DSP
 - 2nd number = software version of the microprocessor
 - Scrolling serial number (also on the QR code label glued to the inside of the cover of the PEL)

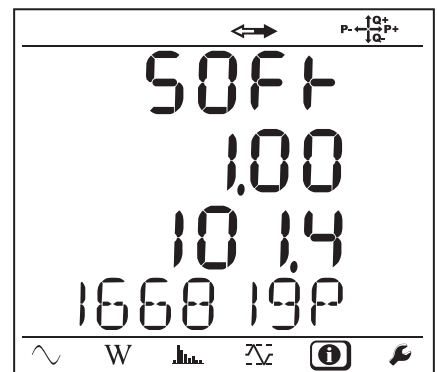

After 3 minutes with no action on the **Enter** or **Navigation** key, the display returns to the measurement screen .

4. USE

When the instrument has been configured, you can use it.

4.1. DISTRIBUTION NETWORKS AND CONNECTIONS

Start by connecting the current sensors and the voltage measurement leads to your installation according to the type of distribution network. The PEL must be configured (see § 3.4) for the distribution network selected.



Always check that the arrow of the current sensor points towards the load. This ensures that the phase angle will be correct for power measurements and other measurements that depend on the phase.

The Source or Load indicator is used for wiring verification and for the Fresnel diagram in PEL Transfer.

However, when a recording session has ended and been uploaded to a PC, it is possible to change the direction of the current (I1, I2, or I3) using the PEL Transfer software. This makes it possible to correct the power calculations on networks with neutral.

4.1.1. SINGLE-PHASE, 2-WIRE: 1P-2W

For Single-Phase 2-Wire measurements:

- Connect the N test lead to the neutral conductor
- Connect the V1 test lead to the L1 phase conductor
- Connect the I1 current probe to the L1 phase conductor.

 Check that the current arrow on the sensor points towards the load. This ensures proper phase angle for Power Measurements and other phase-sensitive measurements.

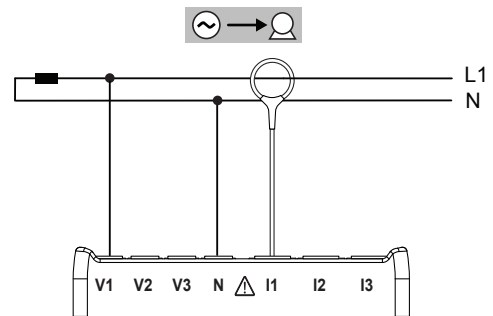



Figure 17

4.1.2. DUAL-PHASE (SINGLE-PHASE 3-WIRE FROM A CENTER TAP TRANSFORMER): 1P-3W

For Single-Phase 3-Wire (Split Phase) measurements:

- Connect the N test lead to the Neutral conductor
- Connect the V1 test lead to the L1 phase conductor
- Connect the V2 test lead to the L2 phase conductor
- Connect the I1 current probe to the L1 phase conductor.
- Connect the I2 current probe to the L2 phase conductor

 Check that the current arrow on the sensor points towards the load. This ensures proper phase angle for Power Measurements and other phase-sensitive measurements.

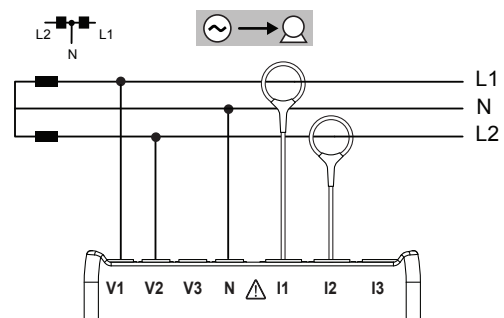

Figure 18

4.1.3. THREE-PHASE 3-WIRE POWER NETWORKS

4.1.3.1. 3-Phase 3-Wire Δ (with 2 current sensors): 3P-3WΔ2

For 3-phase 3-wire Δ measurements using two current sensors:

- Connect the V1 test lead to the L1 phase conductor
- Connect the V2 test lead to the L2 phase conductor
- Connect the V3 test lead to the L3 phase conductor
- Connect the I1 current probe to the L1 phase conductor.
- Connect the I3 current probe to the L3 phase conductor

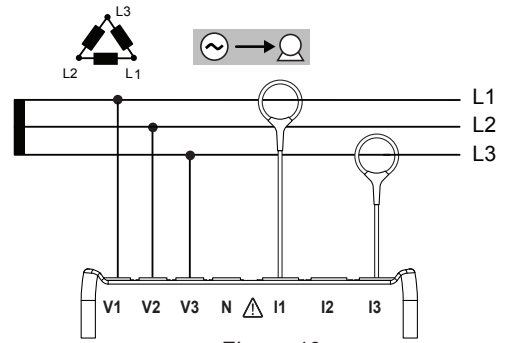

Figure 19

i Check that the current arrow on the sensor points towards the load. This ensures proper phase angle for Power Measurements and other phase-sensitive measurements.

4.1.3.2. 3-Phase 3-Wire Δ (with 3 current sensors): 3P-3WΔ3

For 3-Phase 3-Wire Δ measurements using three current sensors:

- Connect the V1 test lead to the L1 phase conductor
- Connect the V2 test lead to the L2 phase conductor
- Connect the V3 test lead to the L3 phase conductor
- Connect the I1 current probe to the L1 phase conductor.
- Connect the I2 current probe to the L2 phase conductor
- Connect the I3 current probe to the L3 phase conductor

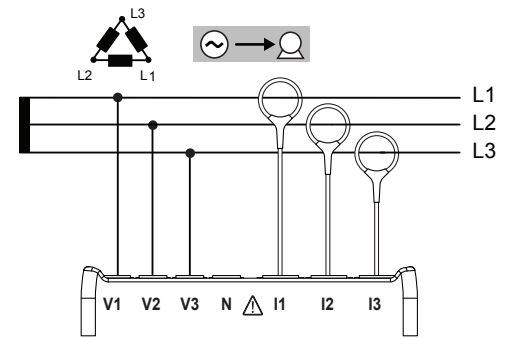

Figure 20

i Check that the current arrow on the sensor points towards the load. This ensures proper phase angle for Power Measurements and other phase-sensitive measurements.

4.1.3.3. 3-Phase 3-Wire Open Δ (with 2 current sensors): 3P-3W02

For 3-Phase 3-Wire Open Δ measurements using two current sensors:

- Connect the V1 test lead to the L1 phase conductor
- Connect the V2 test lead to the L2 phase conductor
- Connect the V3 test lead to the L3 phase conductor
- Connect the I1 current probe to the L1 phase conductor.
- Connect the I3 current probe to the L3 phase conductor

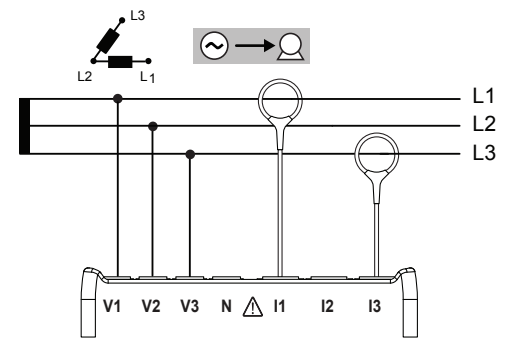

Figure 21

i Check that the current arrow on the sensor points towards the load. This ensures proper phase angle for Power Measurements and other phase-sensitive measurements.

4.1.3.4. 3-Phase 3-Wire Open Δ (with 3 current sensors): 3P-3W03

For 3-Phase 3-Wire Open Δ measurements using three current sensors:

- Connect the V1 test lead to the L1 phase conductor
- Connect the V2 test lead to the L2 phase conductor
- Connect the V3 test lead to the L3 phase conductor
- Connect the I1 current probe to the L1 phase conductor.
- Connect the I2 current probe to the L2 phase conductor
- Connect the I3 current probe to the L3 phase conductor

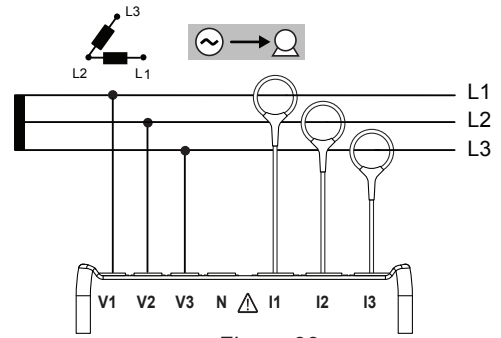

Figure 22



Check that the current arrow on the sensor points towards the load. This ensures proper phase angle for Power Measurements and other phase-sensitive measurements.

4.1.3.5. 3-Phase 3-Wire Y (with 2 current sensors): 3P-3WY2

For 3-Phase 3-Wire Y measurements using two current sensors:

- Connect the V1 test lead to the L1 phase conductor
- Connect the V2 test lead to the L2 phase conductor
- Connect the V3 test lead to the L3 phase conductor
- Connect the I1 current probe to the L1 phase conductor.
- Connect the I3 current probe to the L3 phase conductor

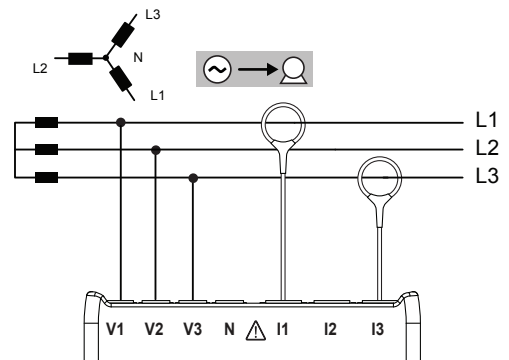

Figure 23



Check that the current arrow on the sensor points towards the load. This ensures proper phase angle for Power Measurements and other phase-sensitive measurements.

4.1.3.6. 3-Phase 3-Wire Y (with 3 current sensors): 3P-3WY

For 3-Phase 3-Wire Y measurements using three current sensors:

- Connect the V1 test lead to the L1 phase conductor
- Connect the V2 test lead to the L2 phase conductor
- Connect the V3 test lead to the L3 phase conductor
- Connect the I1 current probe to the L1 phase conductor.
- Connect the I2 current probe to the L2 phase conductor
- Connect the I3 current probe to the L3 phase conductor

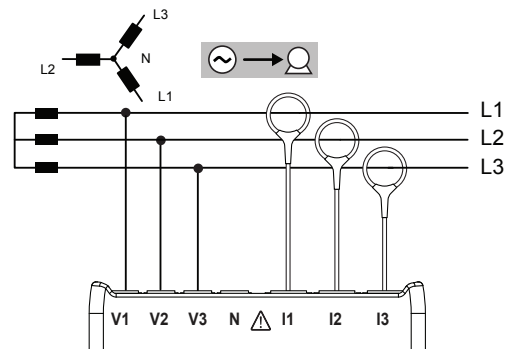

Figure 24



Check that the current arrow on the sensor points towards the load. This ensures proper phase angle for Power Measurements and other phase-sensitive measurements.

4.1.3.7. 3-Phase 3-Wire Δ Balanced (with 1 current sensor): 3P-3WΔB

For 3-Phase 3-Wire Δ Balanced measurements using one current sensor:

- Connect the V1 test lead to the L1 phase conductor
- Connect the V2 test lead to the L2 phase conductor
- Connect the I3 current probe to the L3 phase conductor



Check that the current arrow on the sensor points towards the load. This ensures proper phase angle for Power Measurements and other phase-sensitive measurements.

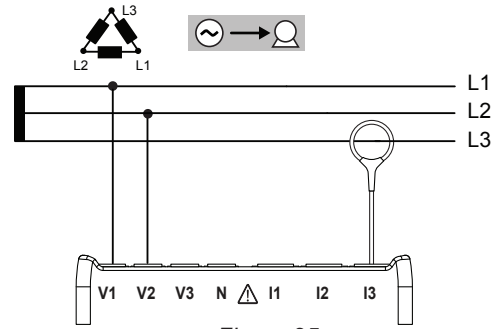

Figure 25

4.1.4. THREE PHASE 4-WIRE Y POWER NETWORKS

4.1.4.1. 3-Phase 4-Wire Y (with 3 current sensors): 3P-4WY

For 3-Phase 4-Wire Y measurements using three current sensors:

- Connect the N test lead to the Neutral conductor
- Connect the V1 test lead to the L1 phase conductor
- Connect the V2 test lead to the L2 phase conductor
- Connect the V3 test lead to the L3 phase conductor
- Connect the I1 current probe to the L1 phase conductor.
- Connect the I2 current probe to the L2 phase conductor
- Connect the I3 current probe to the L3 phase conductor



Check that the current arrow on the sensor points towards the load. This ensures proper phase angle for Power Measurements and other phase-sensitive measurements.

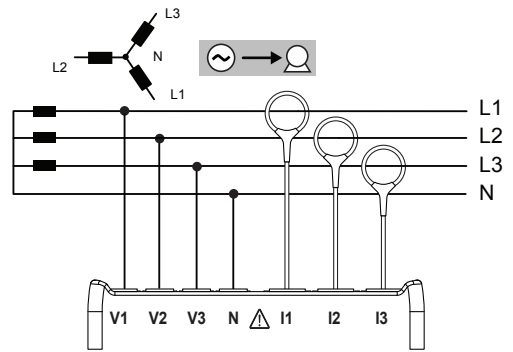

Figure 26

4.1.4.2. 3-Phase 4-Wire Y Balanced: 3P-4WYB

For 3-Phase 3-Wire Balanced Y measurements using one current sensor:

- Connect the V1 test lead to the L1 phase conductor
- Connect the N test lead to the Neutral conductor
- Connect the I1 current probe to the L1 phase conductor



Check that the current arrow on the sensor points towards the load. This ensures proper phase angle for Power Measurements and other phase-sensitive measurements.

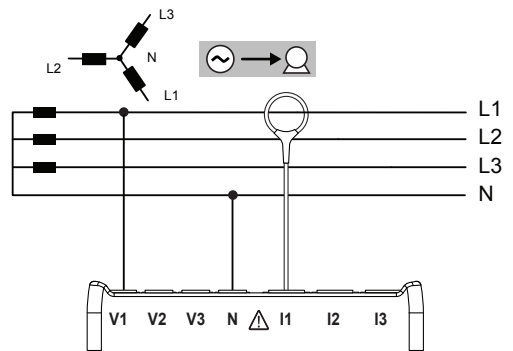

Figure 27

4.1.4.3. 3-Phase 4-Wire Y 2½ Element: 3P-4WY2

For 3-Phase 4-Wire Y 2½ Element measurements using three current sensors:

- Connect the N test lead to the Neutral conductor
- Connect the V1 test lead to the L1 phase conductor
- Connect the V3 test lead to the L3 phase conductor
- Connect the I1 current probe to the L1 phase conductor.
- Connect the I2 current probe to the L2 phase conductor
- Connect the I3 current probe to the L3 phase conductor

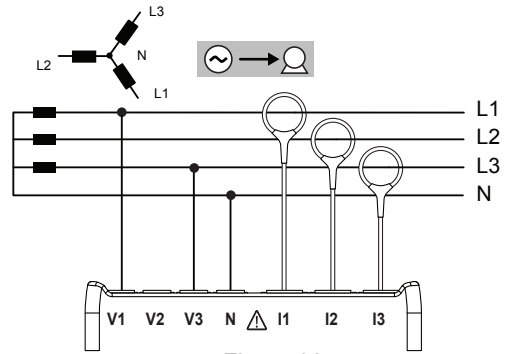

Figure 28



Check that the current arrow on the sensor points towards the load. This ensures proper phase angle for Power Measurements and other phase-sensitive measurements.

4.1.5. 3-PHASE 4-WIRE Δ

High Leg configuration. No Voltage Transformer is connected: the installation under test is assumed to be a low-voltage distribution system.

4.1.5.1. 3-Phase 4-Wire Δ: 3P-4WΔ

For 3-Phase 4-Wire Δ measurements using three current sensors:

- Connect the N test lead to the Neutral conductor
- Connect the V1 test lead to the L1 phase conductor
- Connect the V2 test lead to the L2 phase conductor
- Connect the V3 test lead to the L3 phase conductor
- Connect the I1 current probe to the L1 phase conductor.
- Connect the I2 current probe to the L2 phase conductor
- Connect the I3 current probe to the L3 phase conductor

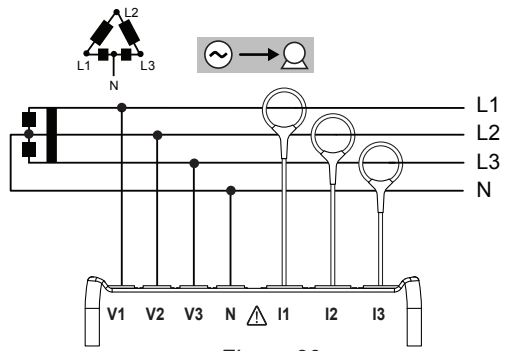

Figure 29



Check that the current arrow on the sensor points towards the load. This ensures proper phase angle for Power Measurements and other phase-sensitive measurements.

4.1.5.2. 3-Phase 4-Wire Open Δ: 3P-4WO

For 3-Phase 4-Wire Open Δ measurements using three current sensors:

- Connect the N test lead to the Neutral conductor
- Connect the V1 test lead to the L1 phase conductor
- Connect the V2 test lead to the L2 phase conductor
- Connect the V3 test lead to the L3 phase conductor
- Connect the I1 current probe to the L1 phase conductor.
- Connect the I2 current probe to the L2 phase conductor
- Connect the I3 current probe to the L3 phase conductor

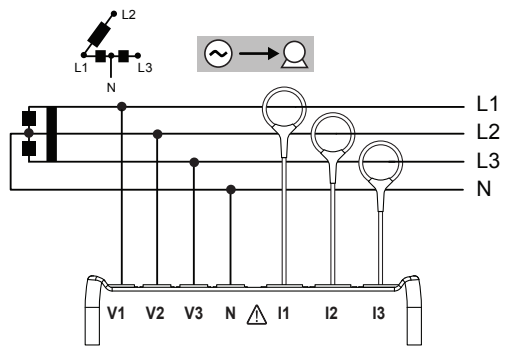

Figure 30



Check that the current arrow on the sensor points towards the load. This ensures proper phase angle for Power Measurements and other phase-sensitive measurements.

4.1.6. DC POWER NETWORKS

4.1.6.1. DC 2-Wire: DC-2W

For DC 2- Wire measurements:

- Connect the N test lead to the negative conductor
- Connect the V1 test lead to positive conductor +1
- Connect the I1 current probe to conductor +1



Check that the current arrow on the sensor points towards the load. This ensures proper phase angle for Power Measurements and other phase-sensitive measurements.

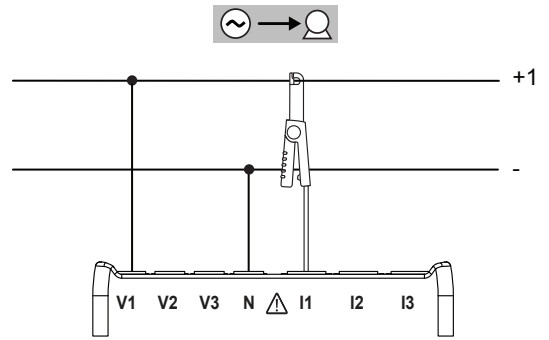

Figure 31

4.1.6.2. DC 3-Wire: DC-3W

For DC 3- Wire measurements:

- Connect the N test lead to the negative conductor
- Connect the V1 test lead to conductor +1
- Connect the V2 test lead to conductor +2
- Connect the I1 current probe to conductor +1
- Connect the I2 current probe to conductor +2



Check that the current arrow on the sensor points towards the load. This ensures proper phase angle for Power Measurements and other phase-sensitive measurements.

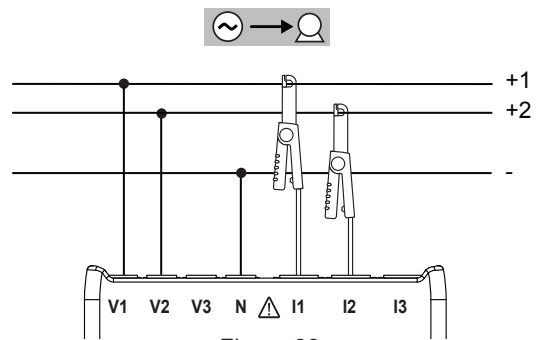

Figure 32

4.1.6.3. DC 4-Wire: DC-4W

For DC 4-Wire measurements and using three current sensors:

- Connect the N test lead to the negative conductor
- Connect the V1 test lead to conductor +1
- Connect the V2 test lead to conductor +2
- Connect the V3 test lead to conductor +3
- Connect the I1 current probe to conductor +1
- Connect the I2 current probe to conductor +2
- Connect the I3 current probe to conductor +3



Check that the current arrow on the sensor points towards the load. This ensures proper phase angle for Power Measurements and other phase-sensitive measurements.

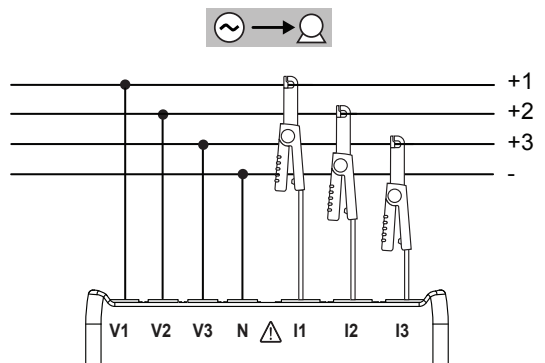





Figure 33

4.2. RECORDING

To start recording:





- Check that there is in fact an SD card (not locked and not full) in the PEL.
- Press the **Selection**  key and hold it down. The **REC** and  indicators light in turn for 3 seconds each.
- Release the **Selection**  key while the **REC** indicator is lit. Recording starts and the **REC** indicator starts blinking twice every 5 seconds.

To stop recording, proceed in exactly the same way. The **REC** indicator starts blinking once every 5 seconds.

It is possible to manage recording from PEL Transfer software (see § 5).

4.3. MEASURED-VALUE DISPLAY MODES

The PEL has 4 display modes, represented by the icons at the bottom of the display unit. To change from one mode to the other, use the ◀ or ▶ key.

Icon	Display mode
	Instantaneous values display mode: voltage (V), current (I), active power (P), reactive power (Q), apparent power (S), frequency (f), power factor (PF), $\tan \Phi$.
	Power and energy display mode: active energy of the load (Wh), reactive energy of the load (Varh), apparent energy of the load (VAh).
	Current and voltage harmonics display mode.
	Maximum values display mode: maximum aggregated values of the measurements and energy of the last recording.

The displays are accessible as soon as the PEL is on, but the values are zero. As soon as there is a voltage or current on the inputs, the values are updated.

4.3.1. MEASUREMENT MODE

The display depends on the network configured. Press the  key to go from one screen to the next.

Single-phase, 2-wire (1P-2W)

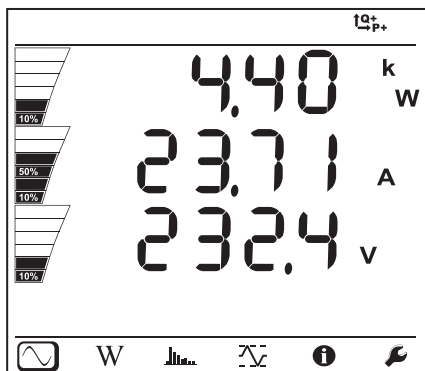

P
I
V

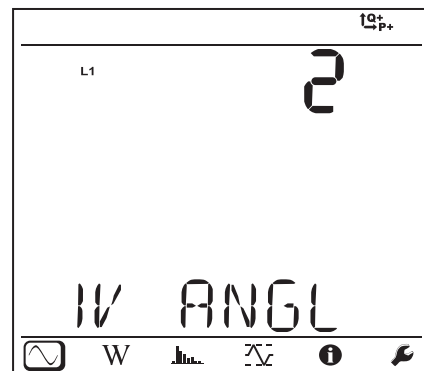

$\varphi (I_1, V_1)$

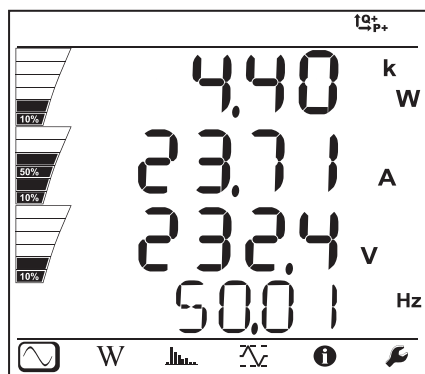

P
I
V
f

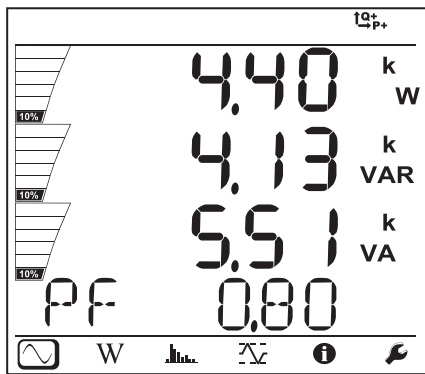

P
Q
S
PF

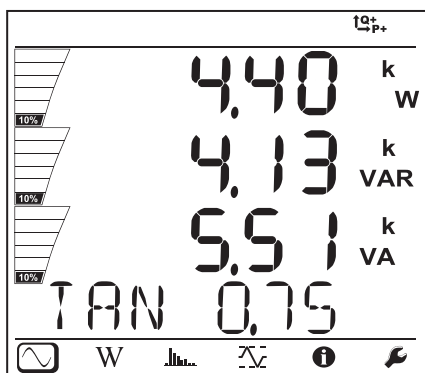

P
Q
S
tan φ

Two-phase, 3-wire (2P-3W)

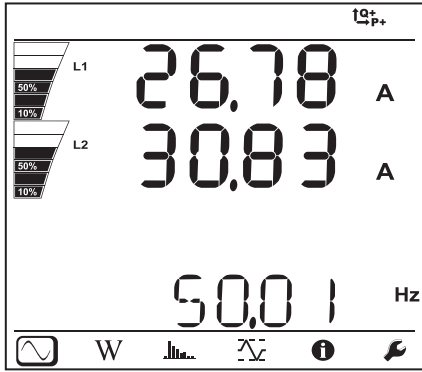

I_1
 I_2
f

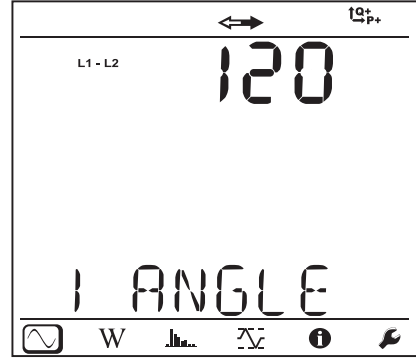

$\phi(I_2, I_1)$

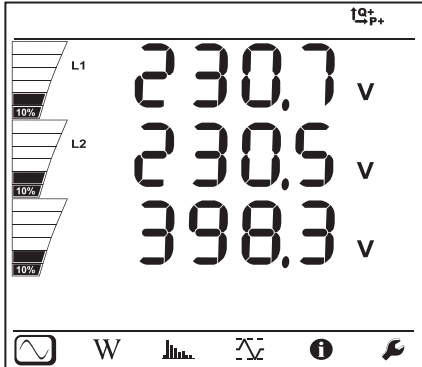

V_1
 V_2
 U_{12}

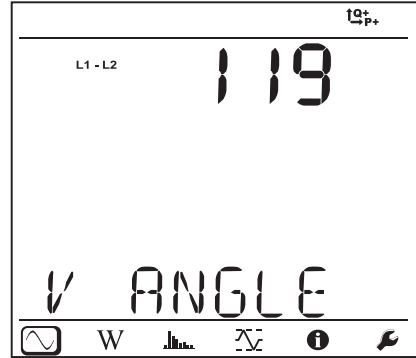

$\phi(V_2, V_1)$

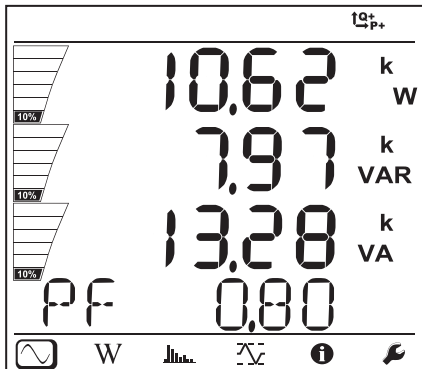

P
Q
S
PF

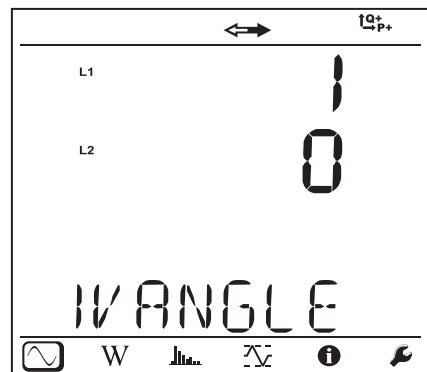

$\phi(I_1, V_1)$

$\phi(I_2, V_2)$

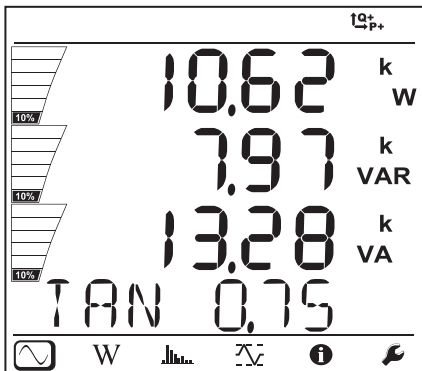

P
Q
S
tan ϕ

Three-phase, 3-wire, unbalanced (3P-3WΔ2, 3P-3WΔ3, 3P-3WO2, 3P-3WO3, 3P-3WY2, 3P-3WY3)

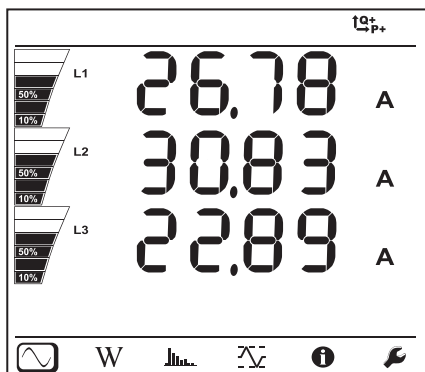

I_1
 I_2
 I_3

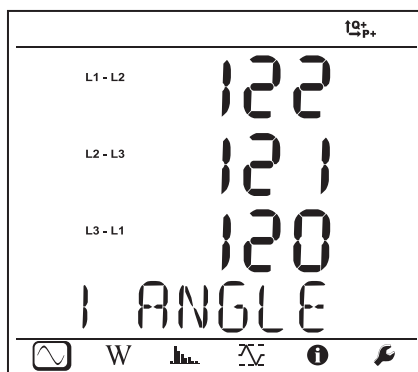

$\phi(I_2, I_1)$
 $\phi(I_3, I_2)$
 $\phi(I_1, I_3)$

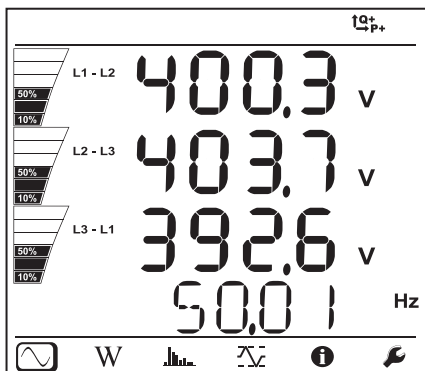

U_{12}
 U_{23}
 U_{31}
 f

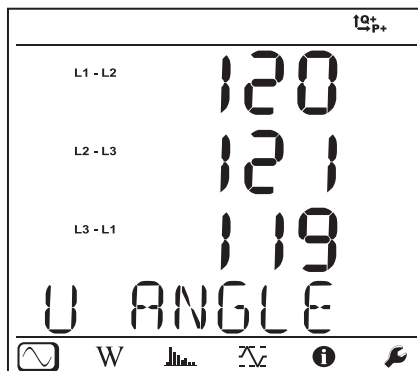

$\phi(U_{31}, U_{23})$
 $\phi(U_{12}, U_{31})$
 $\phi(U_{23}, U_{12})$

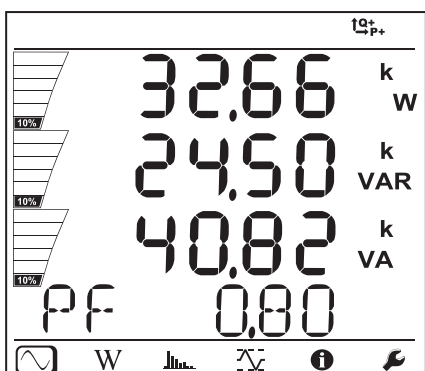

P
 Q
 S
 PF

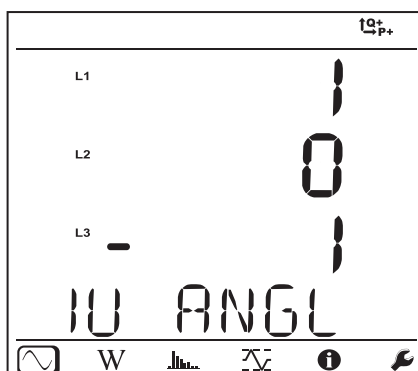

$\phi(I_1, U_{12})$
 $\phi(I_2, U_{23})$
 $\phi(I_3, U_{31})$

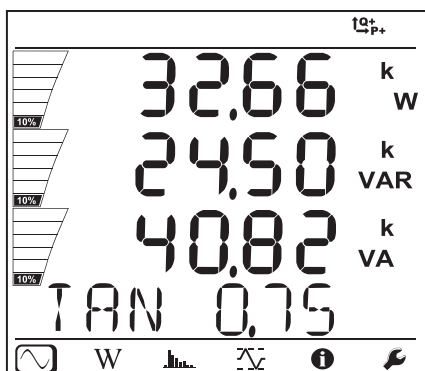

P
 Q
 S
 $\tan \phi$

Three-phase, 3-wire Δ , balanced (3P-3W Δ b)

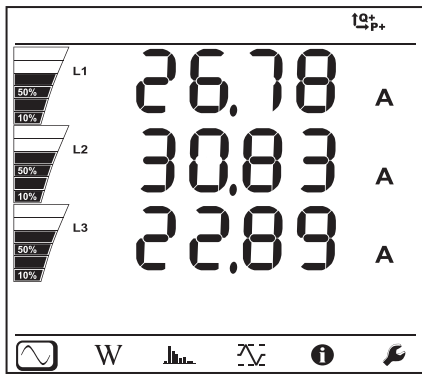

I_1
 I_2
 I_3

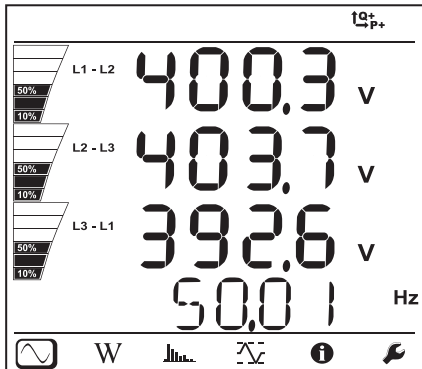

U_{12}
 U_{23}
 U_{31}
 f

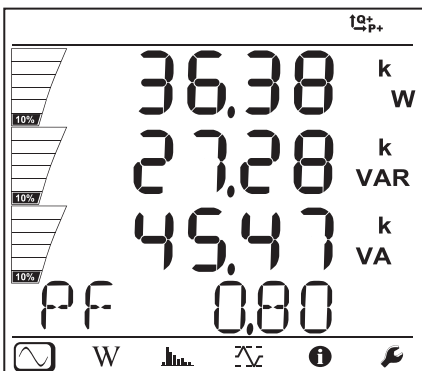

P
 Q
 S
 PF

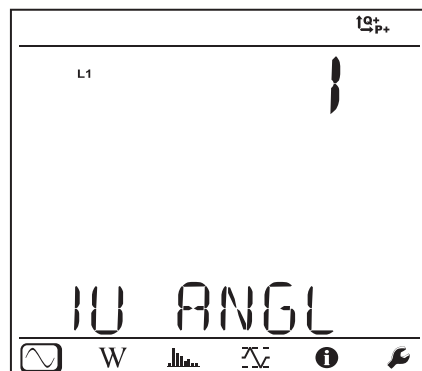

$\phi(I_1, U_{12})$

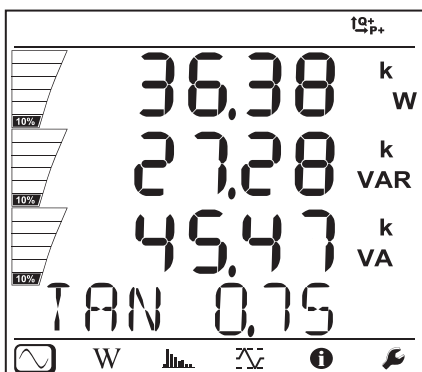

P
 Q
 S
 $\tan \phi$

Three-phase, 4-wire, unbalanced (3P-4WY, 3P-4WY2, 3P-4WΔ, 3P-4WO)

▼		I_1 I_2 I_3 I_N			$\phi(I_2, I_1)$ $\phi(I_3, I_2)$ $\phi(I_1, I_3)$
▼		V_1 V_2 V_3			$\phi(V_2, V_1)^*$ $\phi(V_3, V_2)^*$ $\phi(V_1, V_3)$
▼		U_{12} U_{23} U_{31} f			$\phi(U_{31}, U_{23})$ $\phi(U_{12}, U_{31})$ $\phi(U_{23}, U_{12})$
▼		P Q S PF			$\phi(I_1, V_1)$ $\phi(I_2, V_2)^*$ $\phi(I_3, V_3)$

*: Not for 3P-4WΔ and 3P-4WO networks

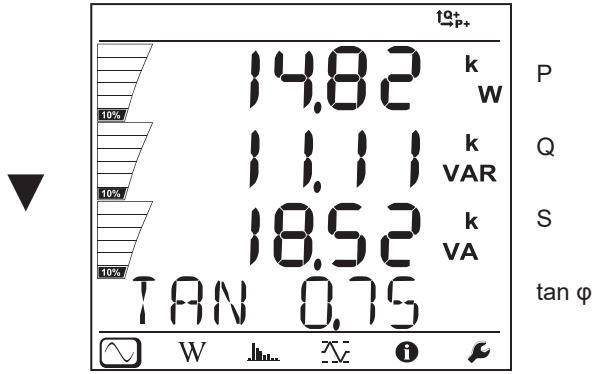

Three-phase, 4-wire, wye, balanced (3P-4WYb)

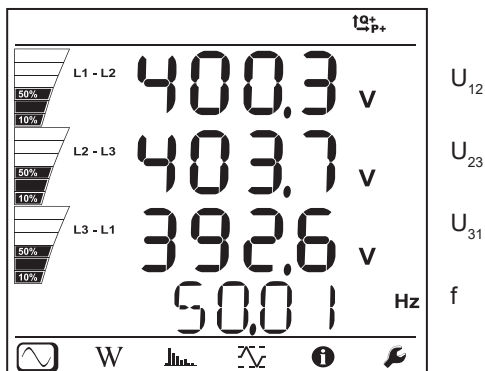
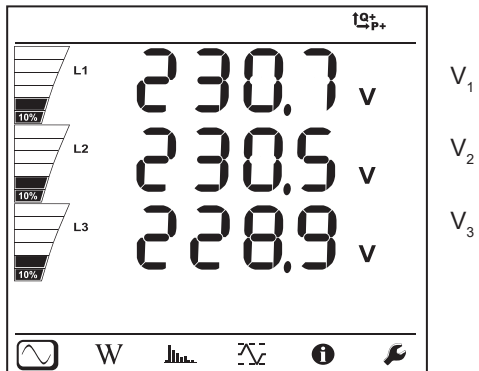
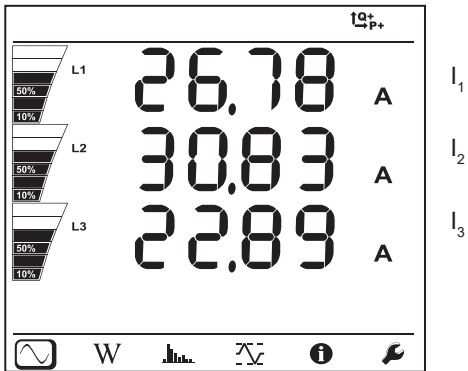

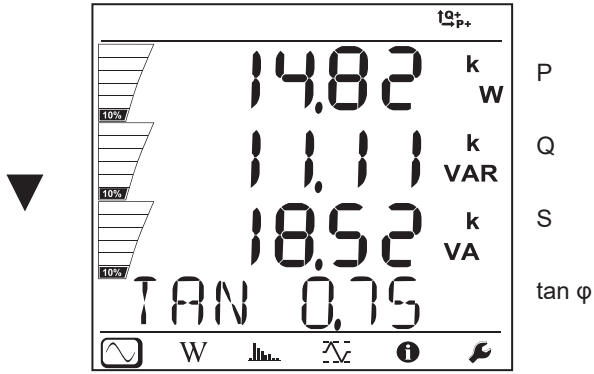
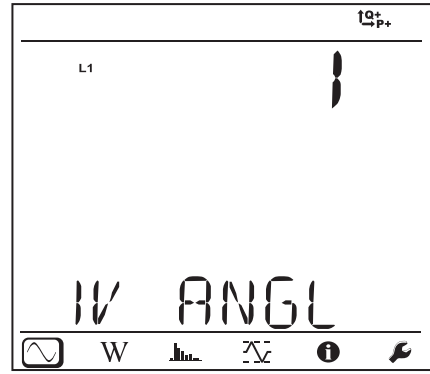
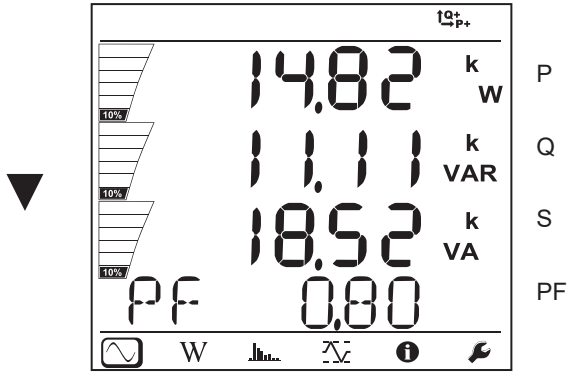

DC 2-wire, (dC-2W)

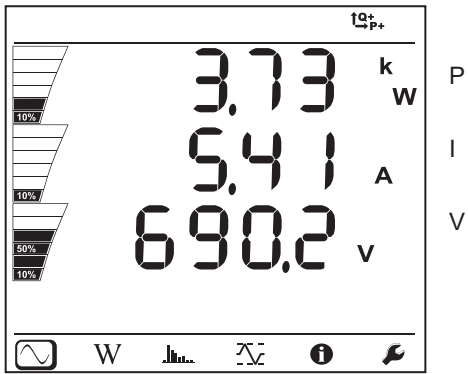

DC 3-wire, (dC-3W)

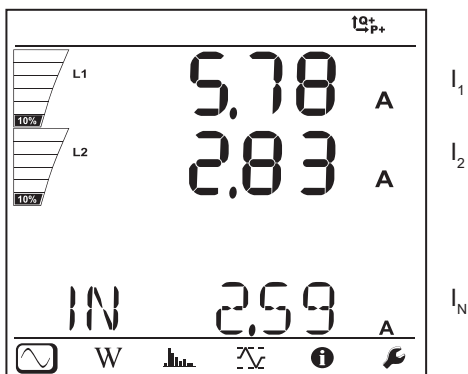

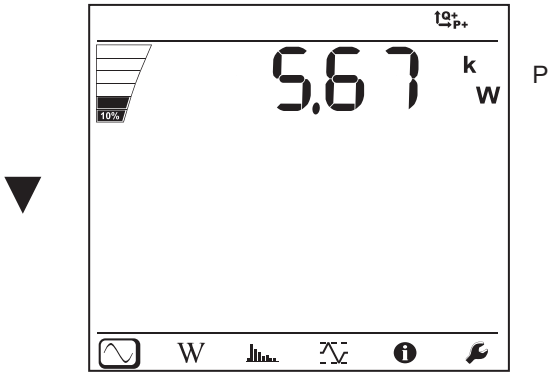
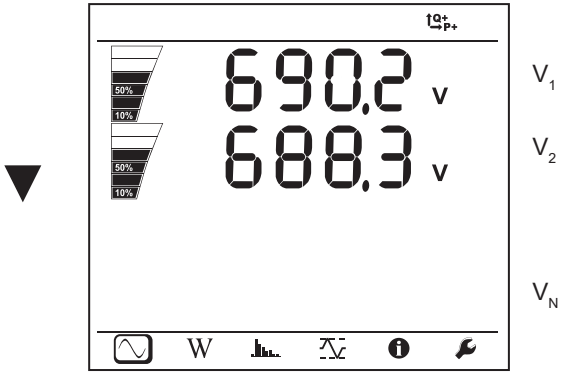

DC 4-wire, (dC-4W)

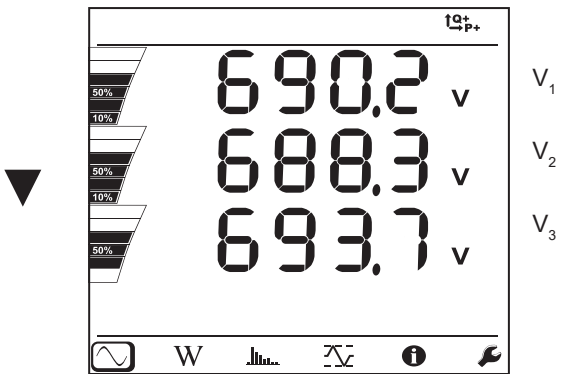
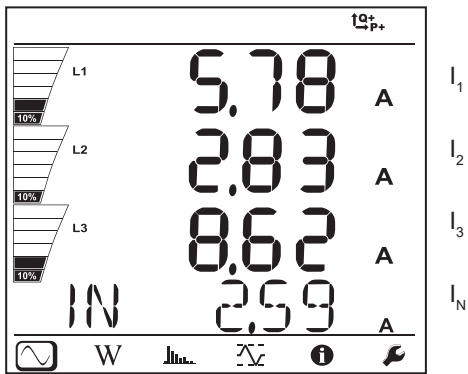

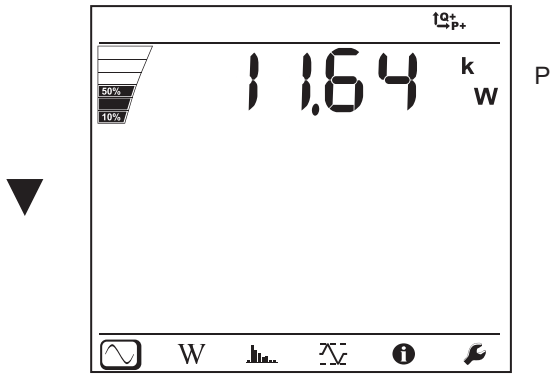

4.3.2. ENERGY MODE W

The powers displayed are the total powers. The energy depends on the duration; typically it is available at the end of 10 or 15 minutes or at the end of the aggregation period.

Press the **Enter** ↵ key for more than 2 seconds to obtain the powers by quadrant. The display unit indicates **Part** to specify that the values are partial.

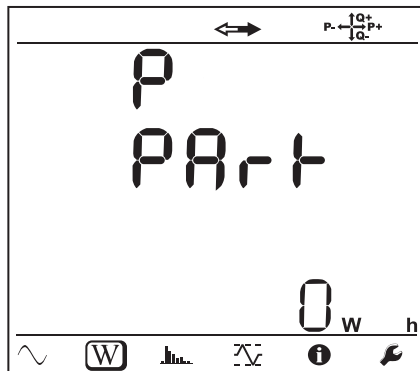

Figure 34

Press the **▼** key to return to display of the total powers.

The display screens for AC and DC networks are different

AC networks

Ep+: Total active energy consumed (by the load) in kWh

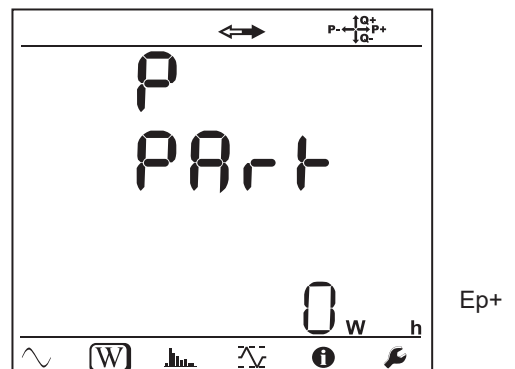
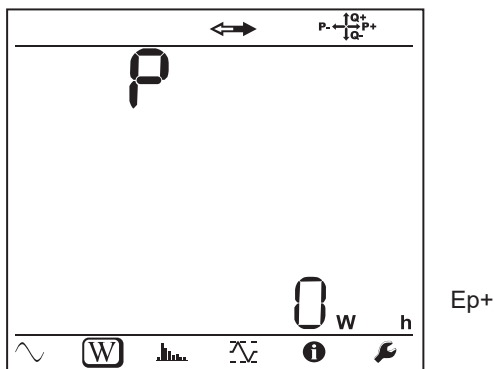

Ep-: Total active energy delivered (by the source) in kWh

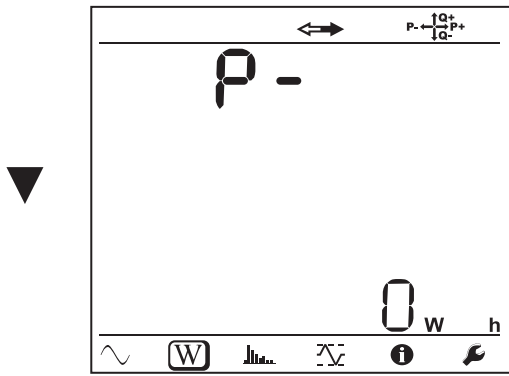

Ep-

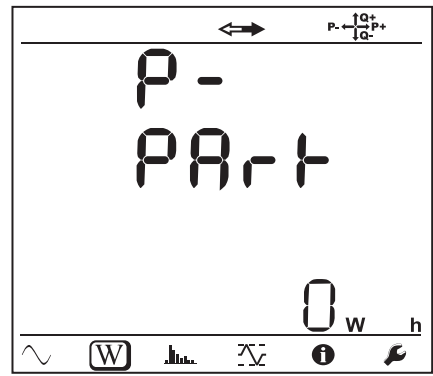

Ep-

Eq1: Reactive energy consumed (by the load) in the inductive quadrant (quadrant 1) in kvarh.

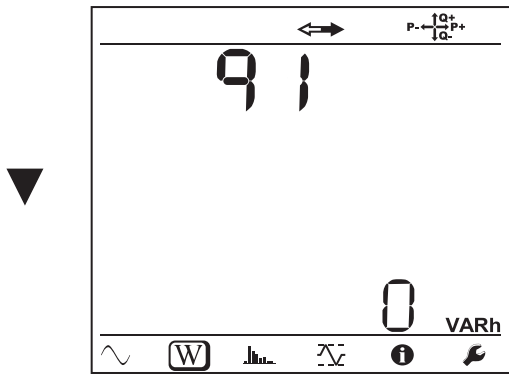

Eq1

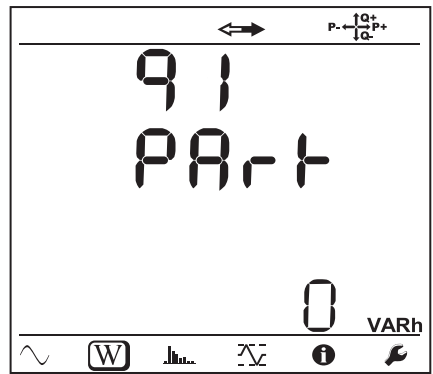

Eq1

Eq2: Reactive energy delivered (by the source) in the capacitive quadrant (quadrant 2) in kvarh.

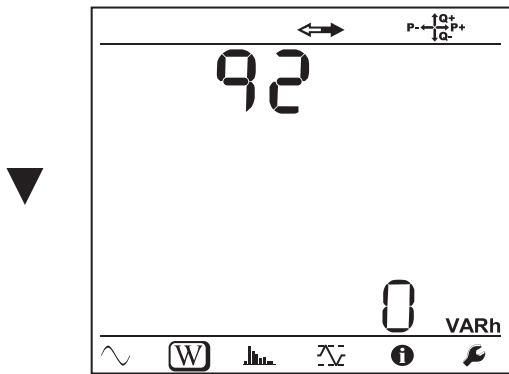

Eq2

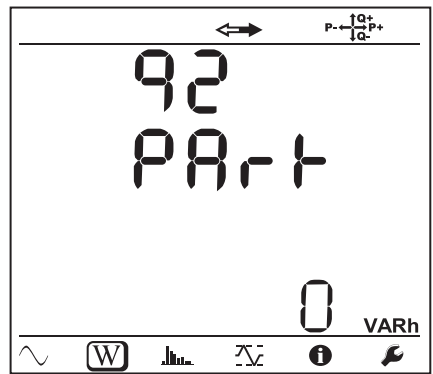

Eq2

Eq3: Reactive energy delivered (by the source) in the inductive quadrant (quadrant 3) in kvarh.

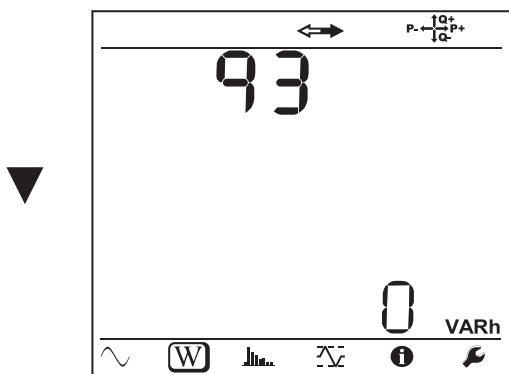

Eq3

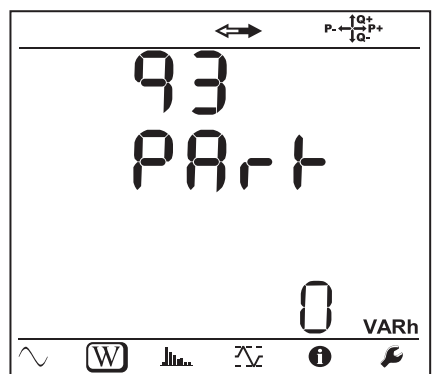

Eq3

Eq4: Reactive energy consumed (by the load) in the capacitive quadrant (quadrant 4) in kvarh.

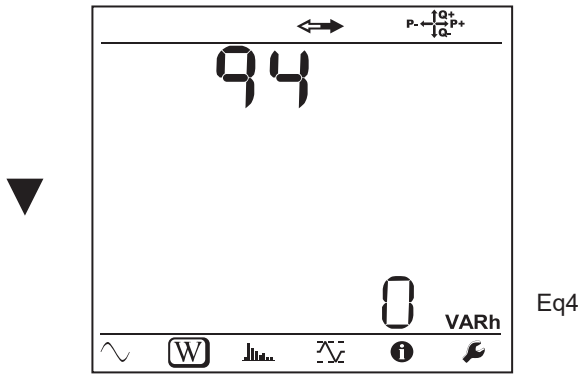

Eq4

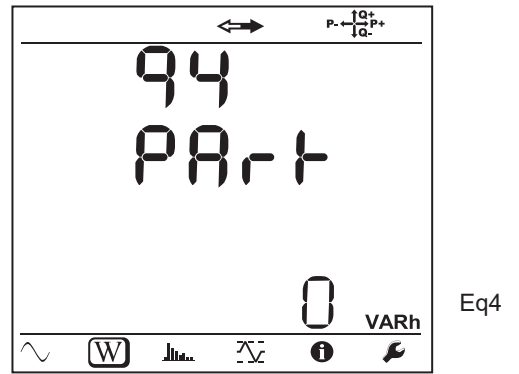

Eq4

Es+: Total apparent energy consumed (by the load) in kVAh

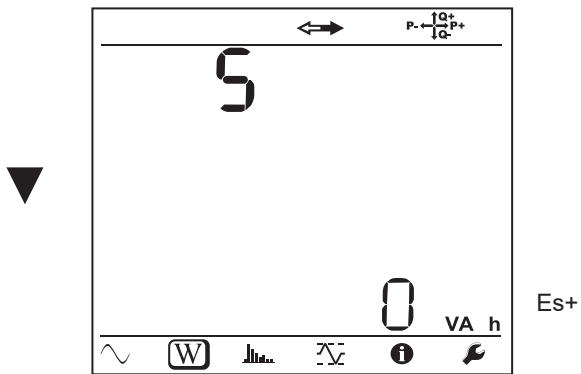

Es+

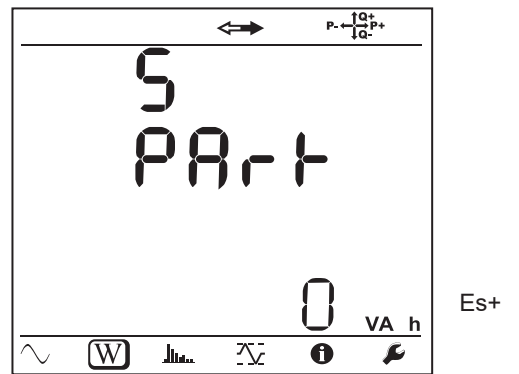

Es+

Es-: Total apparent energy delivered (by the source) in kVAh

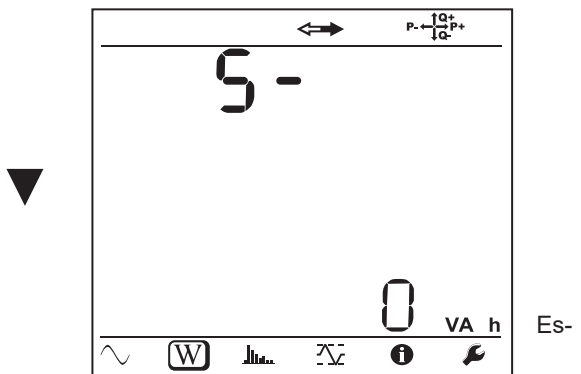

Es-

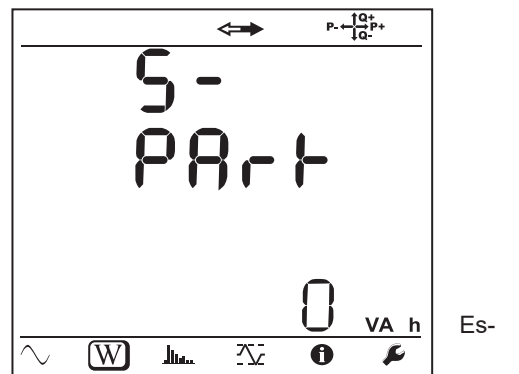

Es-

DC networks

Ep+: Total active energy consumed (by the load) in kWh

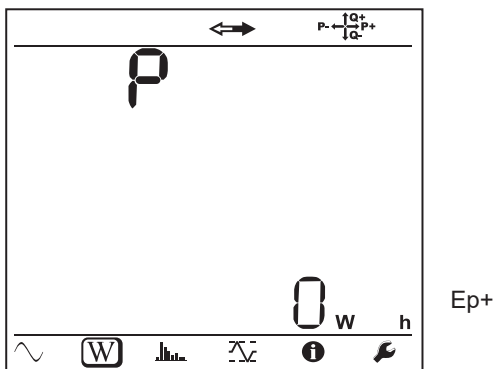

Ep+

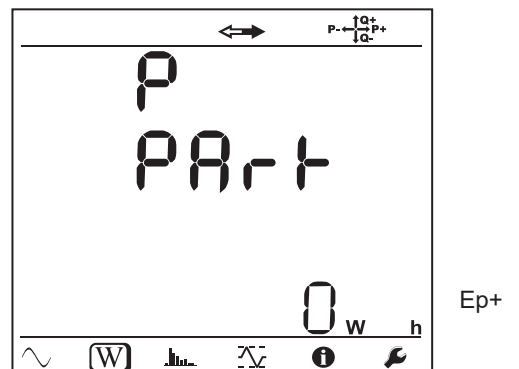

Ep+

Ep-: Total active energy delivered (by the source) in kWh

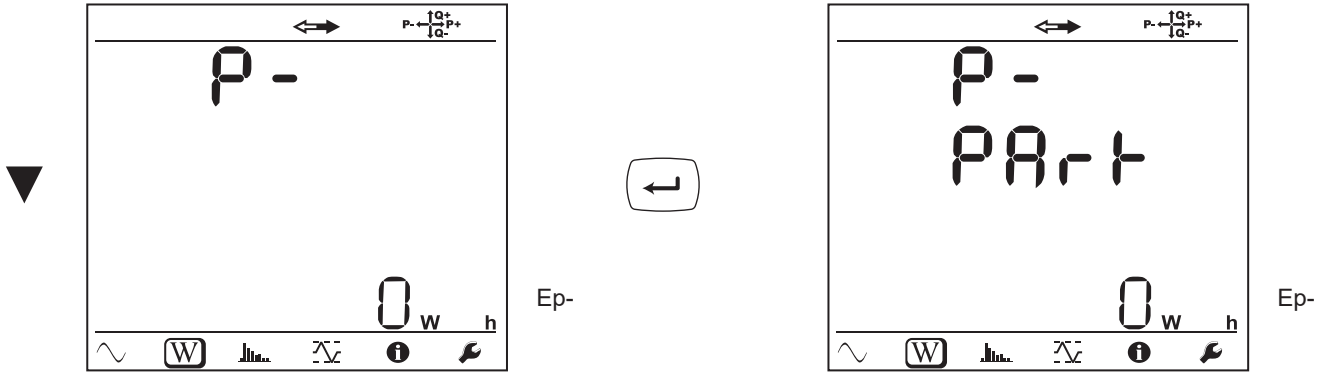

4.3.3. HARMONICS MODE

The display depends on the network configured.
 The harmonics display is not available for DC networks. The display unit indicates "DC mode no THD".

Single-phase, 2-wire (1P-2W)

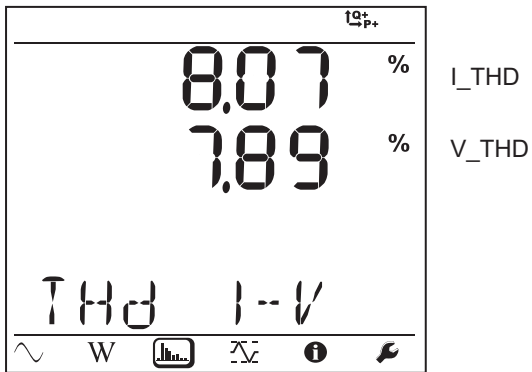

Two-phase, 3-wire (1P-3W)

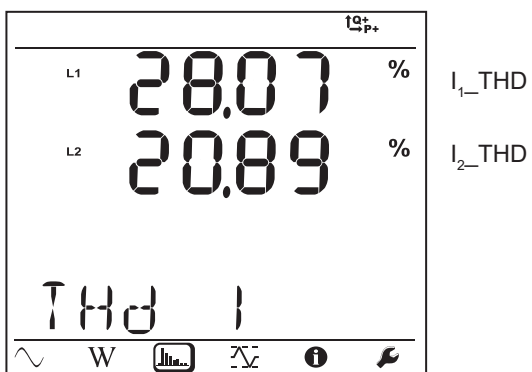

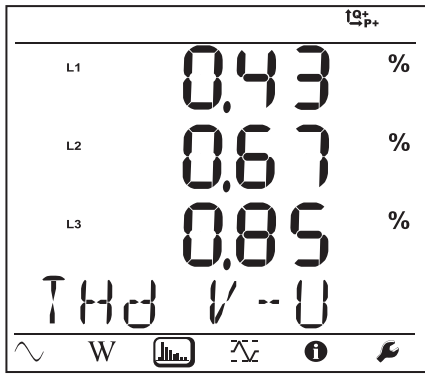

V_{1_THD}

V_{2_THD}

U_{12_THD}

Three-phase, 3-wire, unbalanced (3P-3WΔ2, 3P-3WΔ3, 3P-3WO2, 3P-3WO3, 3P-3WY2, 3P-3WY3)

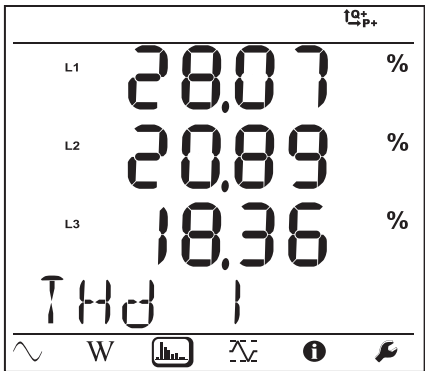

I_{1_THD}

I_{2_THD}

I_{3_THD}

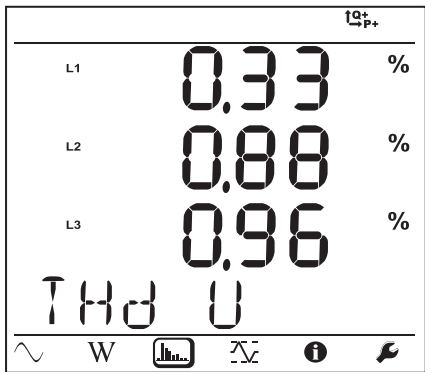

U_{12_THD}

U_{23_THD}

U_{31_THD}

Three-phase, 3-wire Δ, balanced (3P-3WΔb)

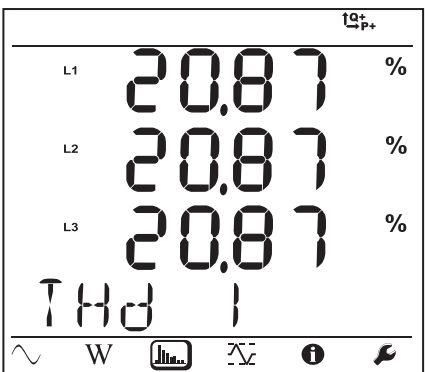

$I_{1_THD} = I_{3_THD}$

$I_{2_THD} = I_{3_THD}$

I_{3_THD}

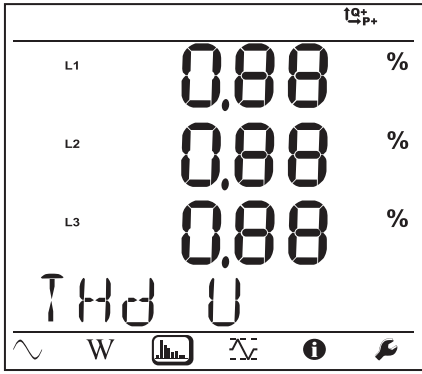

U_{12_THD}

$U_{23_THD} = U_{12_THD}$

$U_{31_THD} = U_{12_THD}$

Three-phase, 4-wire, unbalanced (3P-4WY, 3P-4WY2, 3P-4WΔ, 3P-4WO)

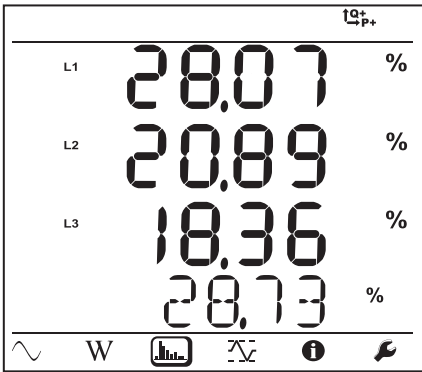

I_{1_THD}

I_{2_THD}

I_{3_THD}

I_{N_THD}

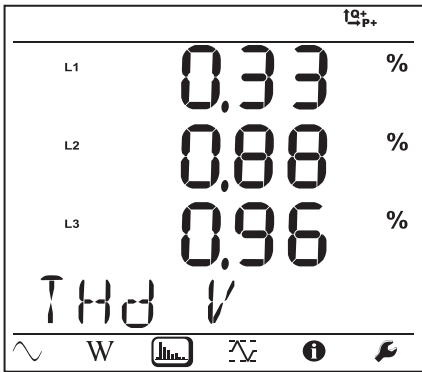

V_{1_THD}

V_{2_THD}

V_{3_THD}

Three-phase, 4-wire, wye, balanced (3P-4WYb)

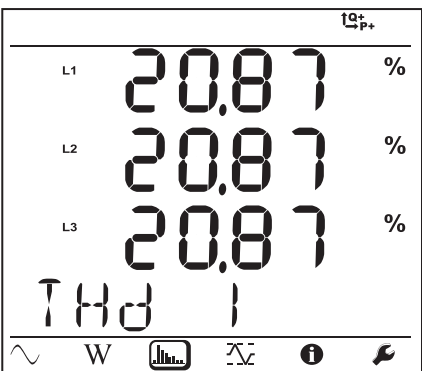

I_{1_THD}

$I_{2_THD} = I_{1_THD}$

$I_{3_THD} = I_{1_THD}$

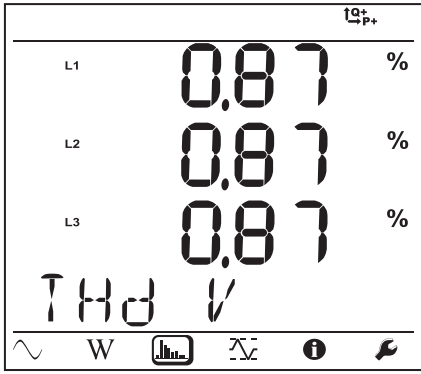

V_{1_THD}

$V_{2_THD} = V_{1_THD}$

$V_{3_THD} = V_{1_THD}$

4.3.4. MAXIMUM MODE

Depending on the option selected in PEL Transfer, these may be the maximum aggregated values of the recording in progress or of the last record, or the maximum aggregated values since the last reset.

The maximum display is not available for DC networks. The display unit indicates "DC Mode no MAX".

Single-phase, 2-wire (1P-2W)

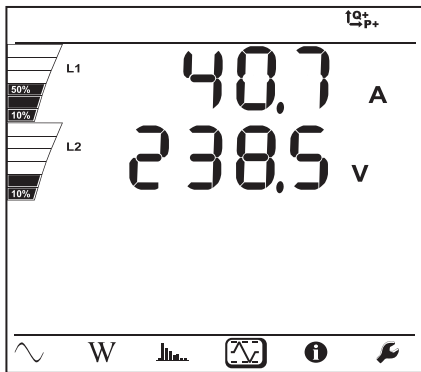

I

V

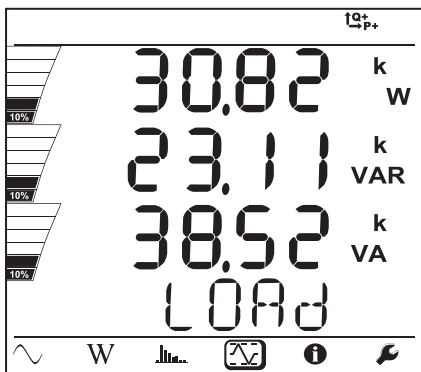

P

Q

S

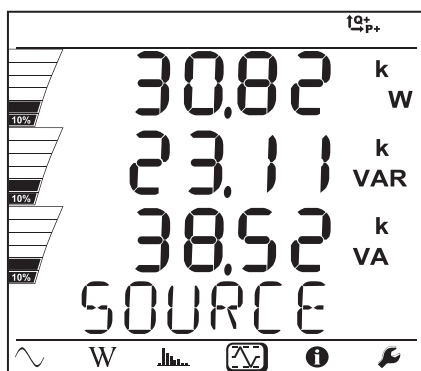

P

Q

S

Two-phase, 3-wire (1P-3W)

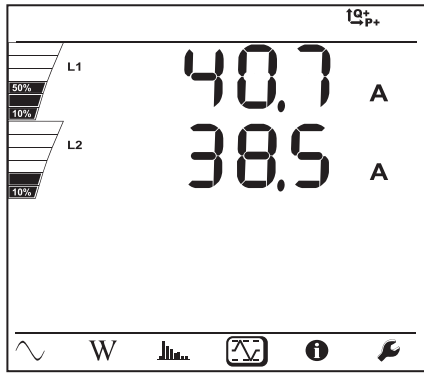

I_1

I_2

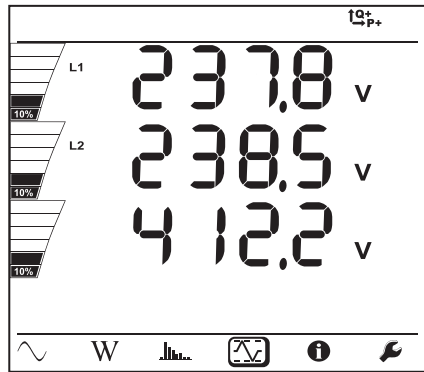

V_1

V_2

U_{12}

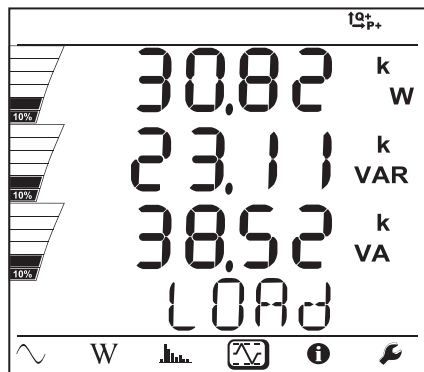

P

Q

S

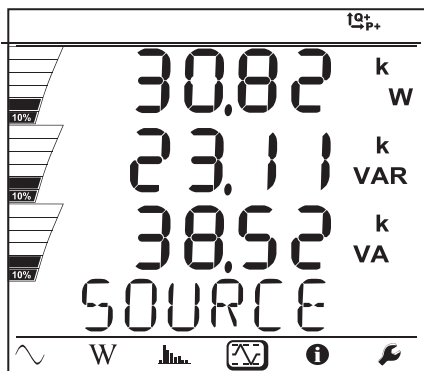

P

Q

S

Three-phase, 3-wire (3P-3WΔ2, 3P-3WΔ3, 3P-3WO2, 3P-3WO3, 3P-3WY2, 3P-3WY3, 3P-3WΔb)

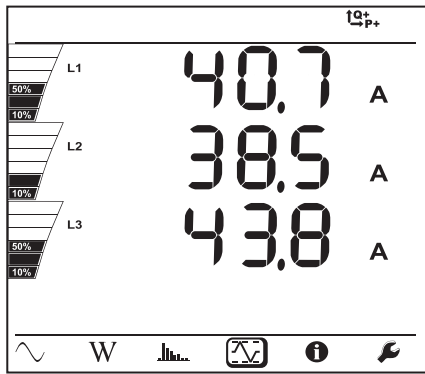

I_1

I_2

I_3

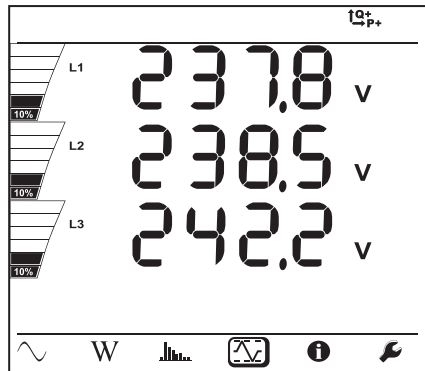

U_{12}

U_{23}

U_{31}

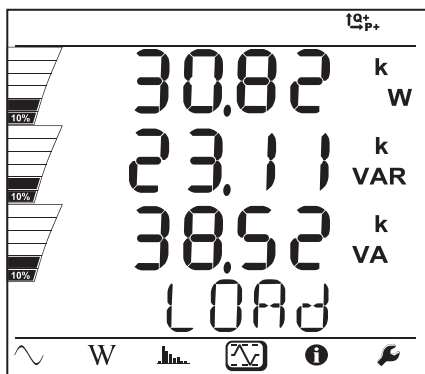

P

Q

S

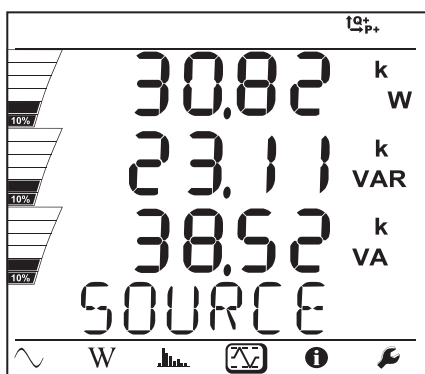

P

Q

S

Three-phase, 4-wire (3P-4WY, 3P-4WY2, 3P-4WΔ, 3P-4WO, 3P-4WYb)

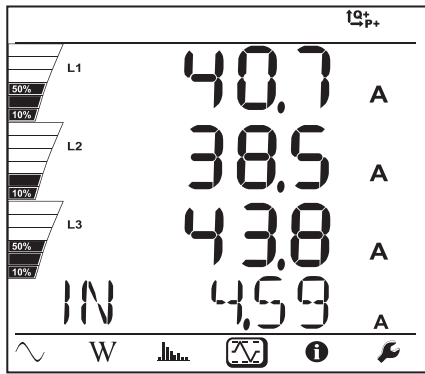

I_1
 I_2
 I_3
 I_N

For the balanced network (3P-4WYb), I_N is not displayed.

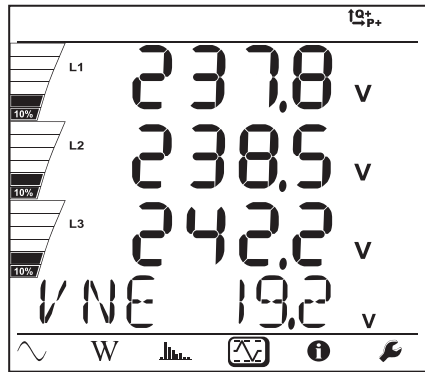

V_1
 V_2
 V_3
 V_N

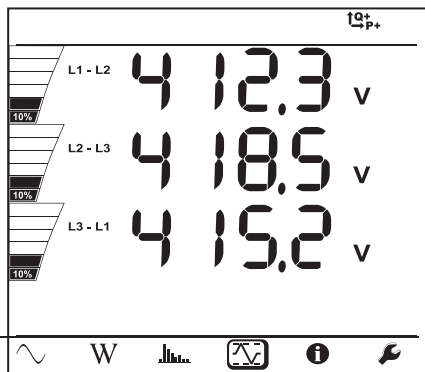

U_{12}
 U_{23}
 U_{31}

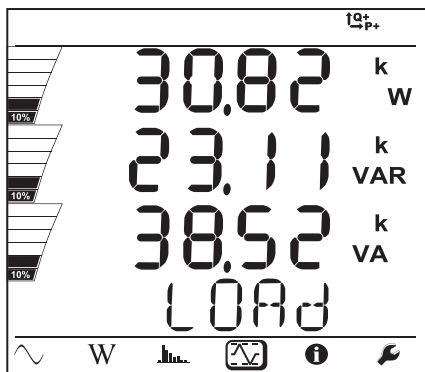

P
Q
S

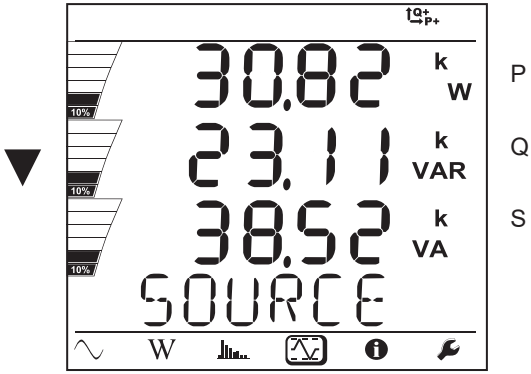

5. SOFTWARE AND APPLICATION

5.1. PEL TRANSFER SOFTWARE

5.1.1. FUNCTIONS

PEL transfer software is used to:

- Connect the instrument to the PC by Wi-Fi, USB, or Ethernet.
- Assign a name to the instrument, choose the brightness and contrast of the display unit, disable or enable the **Selection** key of the instrument, set the date and time, format the SD card, etc.
- Configure communication between the instrument and the PC.
- Configure the measurement: choose the distribution network, the transformation ratio, the frequency, the transformation ratios of the current sensors.
- Configure the records: choose their names, their duration, their starting and ending dates, the aggregation period, whether or not "1s" values and harmonics are recorded.
- Manage energy meters, the operating time of the instrument, the time voltages are present on the measurement inputs, the time currents are present on the measurement inputs, etc.
- Manage the sending of periodic reports by email.

PEL Transfer software can also be used to open records, upload them to the PC, export them to a spreadsheet, view the corresponding curves, and create and print reports.

It is also used to update the internal software of the instrument when a new update is available.

5.1.2. INSTALLING PEL TRANSFER



Do not connect the instrument to the PC until the software and the driver have been installed.

1. Download the latest version of PEL Transfer from our web site:

www.chauvin-arnoux.com

Run **setup.exe**. Then follow the installation instructions.



You must have administrator privileges on your PC to install the PEL Transfer software.

2. A warning message like the one shown below appears. Click on **OK**.

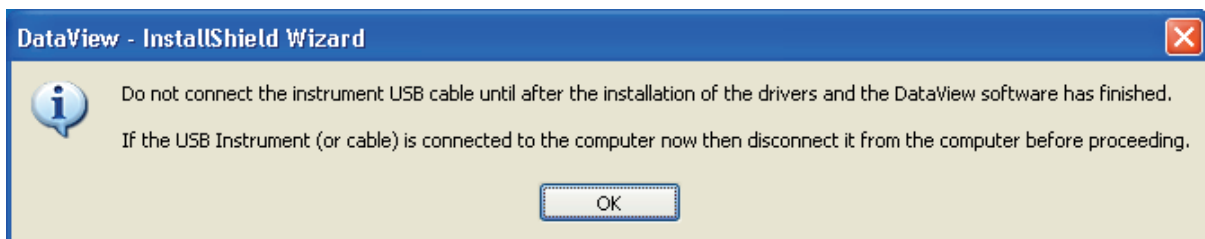

Figure 35



Installing the driver may take some time. Windows may even indicate that the program is no longer responding, even though it is in fact running. Wait for it to terminate.

3. When the driver has been installed, the **Installation succeeded** dialogue box is displayed. Click on **OK**.
4. The **Install Shield Wizard terminated** window is then displayed. Click on **Terminate**.
5. A **Question** dialogue box opens. Click on **Yes** to read the procedure for connecting the instrument to the USB port of the computer. You can select another option to download (for example Adobe® Reader), or user manuals to read, or close the window.



The browser window remains open. You can select another option to download (for example Adobe® Reader), or user manuals to read, or close the window.

6. If necessary, reboot the computer.



A shortcut has been added to your desktop  or in the DataView directory.

You can now open PEL Transfer and connect your PEL to the computer.



For context-sensitive information about the use of PEL Transfer, refer to the Help menu of the software.

5.2. PEL APPLICATION

The Android application provides some of the functions of the PEL Transfer software. It enables you to connect to your instrument remotely.

Find the application by typing PEL Chauvin Arnoux. Install the application on your smartphone or tablet.



PEL

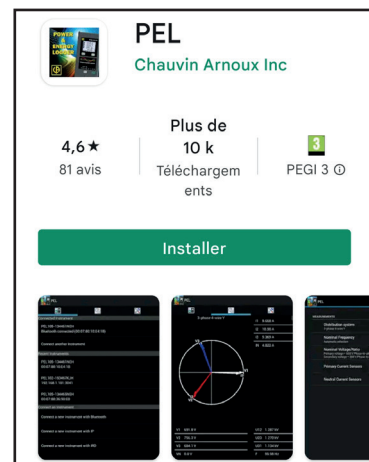

The application has 3 tabs.



is used to connect the instrument:

- by Ethernet. Connect your instrument to the Ethernet network using a cable, then enter its IP address (see §3.5), the port, and the network protocol (this information is available in PEL Transfer). Then log in.
- or by IRD server (DataViewSync™). Enter the serial number of the PEL (see §3.5) and the password (this information is available in PEL Transfer). Then connect.



is used to display the measurements in the form of a Fresnel diagram.

Drag the screen to the left to see the voltage, current, power, and energy values and motor information (speed of rotation, torque), etc.



is used to:

- Configure the records: choose their names, their duration, their start and end dates, the aggregation period, whether or not the “1s” values and harmonics are recorded.
- Configure the measurement: choose the distribution network, the transformation ratio, the frequency, the transformation ratios of the current sensors.
- Configure communication between the instrument and the smartphone or tablet.
- Configure the instrument: set the date and time, format the SD card, lock or unlock the **Selection**  key, enter the motor information, and display the information on the instrument.
- Configure the motor mode in order to be able to display the mechanical power, efficiency, torque and rotational speed of the motor.

6. SPECIFICATIONS

Uncertainties are expressed as a percentage (%) of the reading (R) plus an offset:
 $\pm (a\%R + b)$

6.1. REFERENCE CONDITIONS

Parameter	Reference Condition
Ambient temperature	23 ± 2 °C
Relative humidity	45 to 75% RH
Voltage	No DC component in AC, no AC component in DC (< 0.1 %)
Current	No DC component in AC, no AC component in DC (< 0.1 %)
Supply system frequency	50 Hz ± 0.1 Hz and 60 Hz ± 0.1 Hz
Harmonics	< 0.1%
Voltage unbalance	0%
Preheating	Device powered for at least an hour
Common mode	Neutral input and enclosure are held at earth potential
	Instrument powered on battery, USB disconnected.
Magnetic field	0 A/m AC
Electric field	0 V/m AC

Table 6

6.2. ELECTRICAL SPECIFICATIONS

6.2.1. VOLTAGE INPUTS

Operating Range: up to 1 000 VRMS for phase-to-neutral and phase-to-phase voltages.



Phase-to-neutral voltages lower than 2 V and phase-to-phase voltages lower than 3.4 V are zeroed.

Input Impedance: 1908 kΩ (phase-to-neutral)

Max Overload: 1100 VRMS (phase-to-neutral) at full scale

6.2.2. CURRENT INPUTS



Current sensor outputs are voltages.

Operating Range: 0.5 mV to 1.2 V (1 V = Inom) with crest factor = $\sqrt{2}$ at full scale
 and at least 2.2 at 3% of full scale
 In current measurements, the PEL can withstand a peak factor of 4.1 up to 40% of Inom and 1.7 at Inom.

Input Impedance: 1 MΩ (except for AmpFlex® / MiniFlex current sensors)
 12.4 kΩ (AmpFlex® / MiniFlex current sensors)

Max Overload: 1.7 V

6.2.3. INTRINSIC UNCERTAINTY (EXCLUDING CURRENT SENSORS)

The uncertainties in the tables below are given for the “1s” and aggregated values. For the “200ms” measurements, the uncertainties must be doubled.

6.2.3.1. Specifications at 50/60 Hz

Quantity	Measurement Range	Intrinsic uncertainty
Frequency (f)	[42.5 Hz ; 69 Hz]	± 0.1 Hz
Phase to neutral voltage (V)	[10 V ; 1000 V]	± 0.2%R ± 0.2 V
Phase to phase voltage (U)	[17 V ; 1000 V]	± 0.2%R ± 0.4 V
Current (I) without current sensor *	[0,2% Inom ; 120% Inom]	± 0.4%R ± 0.04% Inom
Active power (P) kW	PF = 1 V = [100 V ; 1000 V] I = [5% Inom ; 120% Inom]	± 0.5%R ± 0.005% Pnom
	PF = [0.5 inductive ; 0.8 capacitive] V = [100 V ; 1000 V] I = [5% Inom ; 120% Inom]	± 1.5%R ± 0.015% Pnom
Reactive power (Q) kvar	Sin φ = 1 V = [100 V ; 1000 V] I = [5% Inom ; 120% Inom]	± 1%R ± 0.01% Qnom
	Sin φ = [0.5 inductive ; 0.5 capacitive] V = [100 V ; 1000 V] I = [10% Inom ; 120% Inom]	± 3.5%R ± 0.03% Qnom
	Sin φ = [0.5 inductive ; 0.5 capacitive] V = [100 V ; 1000 V] I = [5% Inom ; 10% Inom]	± 1%R ± 0.01% Qnom
	Sin φ = [0.25 inductive ; 0.25 capacitive] V = [100 V ; 1000 V] I = [10% Inom ; 120% Inom]	± 2.5%R ± 0.025% Qnom
Apparent power (S) kVA	V = [100 V ; 1000 V] I = [5% Inom ; 120% Inom]	± 0.5%R ± 0.005% Snom
Power factor (PF)	PF = [0.5 inductive ; 0.5 capacitive] V = [100 V ; 1000 V] I = [5% Inom ; 120% Inom]	± 0.05
	PF = [0.2 inductive ; 0.2 capacitive] V = [100 V ; 1000 V] I = [5% Inom ; 120% Inom]	± 0.1
Tan Φ	Tan Φ = [√3 inductive ; √3 capacitive] V = [100 V ; 1000 V] I = [5% Inom ; 120% Inom]	± 0.02
	Tan Φ = [3.2 inductive ; 3.2 capacitive] V = [100 V ; 1000 V] I = [5% Inom ; 120% Inom]	± 0.05
Active energy (Ep) kWh	PF = 1 V = [100 V ; 1000 V] I = [5% Inom ; 120% Inom]	± 0.5%R
	PF = [0.5 inductive ; 0.8 capacitive] V = [100 V ; 1000 V] I = [5% Inom ; 120% Inom]	± 0.6 %R

Quantity	Measurement Range	Intrinsic uncertainty
Reactive energy (Eq) kvarh	Sin $\phi = 1$ V = [100 V ; 1000 V] I = [5% Inom ; 120% Inom]	$\pm 2\%R$
	Sin $\phi = [0.5 \text{ inductive ; } 0.5 \text{ capacitive}]$ V = [100 V ; 1000 V] I = [5% Inom ; 120% Inom]	$\pm 2\%R$
	Sin $\phi = [0.5 \text{ inductive ; } 0.5 \text{ capacitive}]$ V = [100 V ; 1000 V] I = [10% Inom ; 120% Inom]	$\pm 2.5\%R$
	Sin $\phi = [0.25 \text{ inductive ; } 0.25 \text{ capacitive}]$ V = [100 V ; 1000 V] I = [5% Inom ; 10% Inom]	$\pm 2.5\%R$
Apparent energy (Es) kVAh	V = [100 V ; 1000 V] I = [5% Inom ; 120% Inom]	$\pm 0.5\%R$
Harmonics number (1 to 25)	PF = 1 V = [100 V ; 1000 V] I = [5% Inom ; 120% Inom]	$\pm 1\%R$
THD	PF = 1 V = [100 V ; 1000 V] I = [5% Inom ; 120% Inom]	$\pm 1\%R$

Table 7

- Inom is the value of the measured current for a current sensor output of 1 V. See Table 23 and Table 24 for the nominal current values.
- Pnom and Snom are the active power and apparent power for V = 1000 V, I = Inom and PF = 1.
- Qnom is the reactive power for V = 1000 V, I = Inom, and Sin $\phi = 1$.
- *: The intrinsic uncertainty for input current (I) is specified for an isolated input voltage of 1 V = Inom. The intrinsic uncertainty of the connected current sensor should be added to this intrinsic uncertainty to determine the total intrinsic uncertainty. In the case of using sensors AmpFlex® and MiniFlex, intrinsic uncertainty is given in Table 24.
The intrinsic uncertainty for neutral current is the maximum intrinsic uncertainty on I1, I2 and I3.

6.2.3.2. Specifications at 400 Hz

Quantity	Measurement Range	Intrinsic uncertainty
Frequency (f)	[340 Hz ; 460 Hz]	$\pm 0.3 \text{ Hz}$
Phase to neutral voltage (V)	[5 V ; 600 V]	$\pm 0,8\%R \pm 0,5 \text{ V}$
Phase to phase voltage (U)	[10 V ; 600 V]	$\pm 0,8\%R \pm 0,5 \text{ V}$
Current (I) without current sensor *	[0,2% Inom ; 120% Inom] ***	$\pm 0,5\%R \pm 0,05 \% \text{ Inom}$
Active power (P) kW	PF = 1 V = [100 V ; 600 V] I = [5% Inom ; 120% Inom]	$\pm 2\%R \pm 0.2\% \text{ Pnom}^{**}$
	PF = [0.5 inductive ; 0.8 capacitive] V = [100 V ; 600 V] I = [5% Inom ; 120% Inom]	$\pm 3\%R \pm 0.3\% \text{ Pnom}^{**}$
Active energy (Ep) kWh	PF = 1 V = [100 V ; 600 V] I = [5% Inom ; 120% Inom]	$\pm 2\%R^{**}$

Table 8

- Inom is the value of the measured current for a current sensor output at 50/60 Hz. See Table 23 for the nominal current values.
- Pnom is the active power for V = 600 V, I = Inom and PF = 1.
- *: The intrinsic uncertainty for input current (I) is specified for an isolated input voltage of 1 V = Inom. The intrinsic uncertainty of the connected current sensor should be added to this intrinsic uncertainty to determine the total intrinsic uncertainty. In the case of using sensors AmpFlex® and MiniFlex, intrinsic uncertainty is given in Table 24.
The intrinsic uncertainty for neutral current is the maximum intrinsic uncertainty on I1, I2 and I3.
- **: Indicative maximum value of the intrinsic uncertainty. Higher uncertainties can be noted, in particular with EMI.
- ***: For AmpFlex® and MiniFlex, the maximum current is limited to 60% Inom at 50/60 Hz.

6.2.3.3. Specifications in DC

Quantity	Measurement range	Typical intrinsic uncertainty **
Voltage (V)	V = [10 V ; 1000 V]	± 0.2%R ± 0.5 V
Current (I) without current sensor *	I = [5% Inom ; 120% Inom]	± 1%R ± 0.3% Inom
Power (P) kW	V = [100 V ; 600 V] I = [5% Inom ; 120% Inom]	± 1%R ± 0.3% Pnom
Energy (Ep) kWh	V = [100 V ; 600 V] I = [5% Inom ; 120% Inom]	± 1.5%R

Table 9

- Inom is the value of the measured current for a current sensor output of 1 V. See Table 23 for the nominal current values.
- Pnom is the power for V = 600 V and I = Inom.
- *: The intrinsic uncertainty for input current (I) is specified for an isolated input voltage of 1 V = Inom. The intrinsic uncertainty of the connected current sensor should be added to this intrinsic uncertainty to determine the total intrinsic uncertainty. In the case of using sensors AmpFlex® and MiniFlex, intrinsic uncertainty is given in Table 24.
- The intrinsic uncertainty for neutral current is the maximum intrinsic uncertainty on I1, I2 and I3.
- **: Indicative maximum value of the intrinsic uncertainty. Higher uncertainties can be noted, in particular with EMI.

6.2.3.4. Phase order

Conditions for a correct phase order: current phase orders, voltage phase orders and current vs voltage phase order are correct and Source or Load must be selected.

Conditions of correct current phase order

Distribution system	Abbreviation	Current phase order	Comments
1-phase 2-wire	1P-2W	No	
1-phase 3-wire	1P-3W	Yes	$\phi (I2, I1) = 180^\circ \pm 30^\circ$
3-phase 3-wire Δ (2 current sensors)	3P-3WΔ2	Yes	$\phi (I1, I3) = 120^\circ \pm 30^\circ$ No I2 current sensors
3-phase 3-wire Open Δ (2 current sensors)	3P-3W02		
3-phase 3-wire Y (2 current sensors)	3P-3WY2		
3-phase 3-wire Δ (3 current sensors)	3P-3WΔ3	Yes	$[\phi (I1, I3), \phi (I3, I2), \phi (I2, I1)] = 120^\circ \pm 30^\circ$
3-phase 3-wire Open Δ (3 current sensors)	3P-3W03		
3-phase 3-wire Y (3 current sensors)	3P-3WY3		
3-phase 3-wire Δ balanced	3P-3WΔB	No	
3-phase 4-wire Y	3P-4WY	Yes	$[\phi (I1, I3), \phi (I3, I2), \phi (I2, I1)] = 120^\circ \pm 30^\circ$
3-phase 4-wire Y balanced	3P-4WYB	No	
3-phase 4-wire Y 2½	3P-4WY2	Yes	$[\phi (I1, I3), \phi (I3, I2), \phi (I2, I1)] = 120^\circ \pm 30^\circ$
3-phase 4-wire Δ	3P-4WΔ	Yes	$[\phi (I1, I3), \phi (I3, I2), \phi (I2, I1)] = 120^\circ \pm 30^\circ$
3-phase 4-wire Open Δ	3P-4WO		
DC 2-wire	DC-2W	No	
DC 3-wire	DC-3W	No	
DC 4-wire	DC-4W	No	

Table 10

Conditions of correct voltage phase order

Distribution system	Abbreviation	Voltage phase order	Comments
1-phase 2-wire	1P-2W	No	
1-phase 3-wire	1P-3W	Yes	$\varphi (V2, V1) = 180^\circ \pm 10^\circ$
3-phase 3-wire Δ (2 current sensors)	3P-3W Δ 2	Yes (on U)	$[\varphi (U12, U31), \varphi (U31, U23), \varphi (U23, U12)] = 120^\circ \pm 10^\circ$
3-phase 3-wire Open Δ (2 current sensors)	3P-3W02		
3-phase 3-wire Y (2 current sensors)	3P-3WY2		
3-phase 3-wire Δ (3 current sensors)	3P-3W Δ 3	Yes (on U)	$[\varphi (U12, U31), \varphi (U31, U23), \varphi (U23, U12)] = 120^\circ \pm 10^\circ$
3-phase 3-wire Open Δ (3 current sensors)	3P-3W03		
3-phase 3-wire Y (3 current sensors)	3P-3WY3		
3-phase 3-wire Δ balanced	3P-3W Δ B	No	
3-phase 4-wire Y	3P-4WY	Yes (on V)	$[\varphi (V1, V3), \varphi (V3, V2), \varphi (V2, V1)] = 120^\circ \pm 10^\circ$
3-phase 4-wire Y balanced	3P-4WYB	No	
3-phase 4-wire Y 2½	3P-4WY2	Yes (on V)	$\varphi (V1, V3) = 120^\circ \pm 10^\circ$, no V2
3-phase 4-wire Δ	3P-4W Δ	Yes (on U)	$\varphi (V1, V3) = 180^\circ \pm 10^\circ$ $[\varphi (U12, U31), \varphi (U31, U23), \varphi (U23, U12)] = 120^\circ \pm 10^\circ$
3-phase 4-wire Open Δ	3P-4W0		
DC 2-wire	DC-2W	No	
DC 3-wire	DC-3W	No	
DC 4-wire	DC-4W	No	

Table 11

Conditions of correct current vs voltage phase order

Distribution system	Abbreviation	Current vs voltage phase order	Comments
1-phase 2-wire	1P-2W	Yes	$\varphi (I1, V1) = 0^\circ \pm 60^\circ$ for load $\varphi (I1, V1) = 180^\circ \pm 60^\circ$ for source
1-phase 3-wire	1P-3W	Yes	$[\varphi (I1, V1), \varphi (I2, V2)] = 0^\circ \pm 60^\circ$ for load $[\varphi (I1, V1), \varphi (I2, V2)] = 180^\circ \pm 60^\circ$ for source
3-phase 3-wire Δ (2 current sensors)	3P-3W Δ 2	Yes	$[\varphi (I1, U12), \varphi (I3, U31)] = 30^\circ \pm 60^\circ$ for load $[\varphi (I1, U12), \varphi (I3, U31)] = 210^\circ \pm 60^\circ$ for source, no I2 current sensor
3-phase 3-wire Open Δ (2 current sensors)	3P-3W02		
3-phase 3-wire Y (2 current sensors)	3P-3WY2		
3-phase 3-wire Δ (3 current sensors)	3P-3W Δ 3	Yes	$[\varphi (I1, U12), \varphi (I2, U23), \varphi (I3, U31)] = 30^\circ \pm 60^\circ$ for load $[\varphi (I1, U12), \varphi (I2, U23), \varphi (I3, U31)] = 210^\circ \pm 60^\circ$ for source
3-phase 3-wire Open Δ (3 current sensors)	3P-3W03		
3-phase 3-wire Y (3 current sensors)	3P-3WY3		
3-phase 3-wire Δ balanced	3P-3W Δ B	Yes	$\varphi (I3, U12) = 90^\circ \pm 60^\circ$ for load $\varphi (I3, U12) = 270^\circ \pm 60^\circ$ for source
3-phase 4-wire Y	3P-4WY	Yes	$[\varphi (I1, V1), \varphi (I2, V2), \varphi (I3, V3)] = 0^\circ \pm 60^\circ$ for load $[\varphi (I1, V1), \varphi (I2, V2), \varphi (I3, V3)] = 180^\circ \pm 60^\circ$ for source
3-phase 4-wire Y balanced	3P-4WYB	Yes	$\varphi (I1, V1) = 0^\circ \pm 60^\circ$ for load $\varphi (I1, V1) = 180^\circ \pm 60^\circ$ for source
3-phase 4-wire Y 2½	3P-4WY2	Yes	$[\varphi (I1, V1), \varphi (I3, V3)] = 0^\circ \pm 60^\circ$ for load $[\varphi (I1, V1), \varphi (I3, V3)] = 180^\circ \pm 60^\circ$ for source, no V2
3-phase 4-wire Δ	3P-4W Δ	Yes	$[\varphi (I1, U12), \varphi (I2, U23), \varphi (I3, U31)] = 30^\circ \pm 60^\circ$ for load $[\varphi (I1, U12), \varphi (I2, U23), \varphi (I3, U31)] = 210^\circ \pm 60^\circ$ for source
3-phase 4-wire Open Δ	3P-4W0		
DC 2-wire	DC-2W	No	
DC 3-wire	DC-3W	No	
DC 4-wire	DC-4W	No	

Table 12

Load or source is set by configuration.

6.2.3.5. Temperature

For V, U, I, P, Q, S, PF, and E:

- 300 ppm/°C, with 5% < I < 120% and PF = 1
- 500 ppm/°C, with 10% < I < 120% and PF = 0.5 inductive

DC offset

- V: 10 mv/°C typical
- I: 30 ppm Inom /°C typical

6.2.3.6. Magnetic field influence

For current inputs to which MiniFlex or AmpFlex® flexible current sensors are connected: 10 mA/A/m typically at 50/60 Hz.

6.2.4. CURRENT SENSORS

6.2.4.1. Precautions for use



Refer to the safety sheet or user's manual that was supplied with your current sensors.

Current clamps and flexible current sensors are used to measure the current flowing in a cable without opening the circuit. They also insulate the user from dangerous voltages in the circuit.

The choice of current sensor to be used depends on the current to be measured and the diameter of the cables. When installing current sensors, have the arrow on the probe or sensor point towards the load.

6.2.4.2. Specifications

The measurement ranges are those of the sensors. In some cases, they may differ from the ranges that can be measured by the PEL. Refer to the user manual distributed with the current sensor.

a) MiniFlex MA194

The MiniFlex Flexible Current Sensor can be used to measure the current in a cable without opening the circuit. It also serves to isolate the user from hazardous voltages in the circuit. This sensor can only be used as an accessory of an instrument. If you have several sensors, you can mark each of them before connecting it using one of the color-coded rings supplied with the instrument to identify the phase. Then connect the sensor to the instrument.

- Press the yellow opening device to open the sensor. Then, place it around the conductor through which the current to be measured flows (only one conductor per sensor).



- Close the sensor. In order to optimize measurement quality, it is best to center the conductor in the sensor and make the shape of the sensor as circular as possible.
- To disconnect the sensor, open it and withdraw it from the conductor. Then disconnect the sensor from the instrument.

MiniFlex MA194	
Nominal Range	100 / 400 / 2,000 / 10,000 Aac (for the 1000 mm model)
Measurement Range	200 mA to 10,000 AAC
Maximum Clamping Diameter	Length = 250 mm; Ø = 70 mm Length = 350 mm; Ø = 100 mm Length = 1000 mm; Ø = 320 mm
Variation of the position of the conductor in the sensor	≤ 2,5%
Adjacent conductor carrying alternating current	> 40 dB typical at 50/60 Hz for a conductor touching the sensor and > 33 dB near the snap
Safety	IEC/EN 61010-2-032 or BS EN 61010-2-032, Pollution degree 2, 600 V CAT IV, 1000 V CAT III

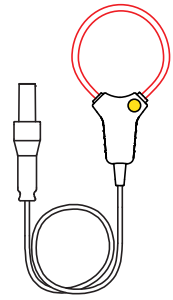

Table 13

Note: Currents < 0.05% of the nominal range will be set to zero.
The nominal ranges are reduced to 50/200/1,000/5,000 AAC at 400 Hz.

b) PAC93 clamp

Note: Power calculations are zeroed when the current is zeroed.

PAC93 clamp	
Nominal Range	1000 AAC, 1300 ADC max
Measurement Range	1 to 1000 AAC, 1 to 1300 APEAK AC+DC
Maximum Clamping Diameter	One 42 mm or two 25.4 mm conductors or two 50 x 5 mm bus bars
Variation of the position of the conductor in the clamp	< 0,5%, DC to 440 Hz
Adjacent conductor carrying alternating current	> 40 dB at 50/60Hz
Safety	IEC/EN 61010-2-032 or BS EN 61010-2-032, Pollution degree 2, 300 V CAT IV, 600 V CAT III

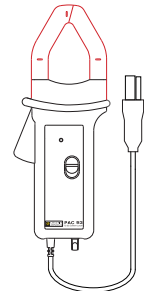

Table 14

Note: Currents < 1 AAC/DC will be set to zero in AC distribution systems.

c) C193 clamp

C193 clamp	
Nominal Range	1000 AAC for f ≤1 kHz
Measurement Range	0.5 to 1200 AAC max (I >1000 A more than 5 minutes)
Maximum Clamping Diameter	52 mm
Variation of the position of the conductor in the clamp	< 0,1%, DC to 440 Hz
Adjacent conductor carrying alternating current	> 40 dB typical at 50/60 Hz
Safety	IEC/EN 61010-2-032 or BS EN 61010-2-032, Pollution degree 2, 600 V CAT IV, 1000 V CAT III

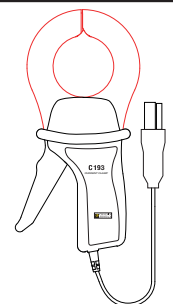

Table 15

Note: Currents < 0.5 A will be set to zero.

d) AmpFlex® A193

AmpFlex® A193		
Nominal Range	100 / 400 / 2.000 / 10.000 AAC	
Measurement Range	0.05 to 12000 AAC	
Maximum Clamping Diameter	Length = 450 mm; Ø = 120 mm Length = 800 mm; Ø = 235 mm	
Variation of the position of the conductor in the sensor	≤ 2 % any position and ≤ 4 % near snap device	
Adjacent conductor carrying alternating current	> 40 dB typical at 50/60 Hz everywhere and > 33 dB near the snap	
Safety	IEC/EN 61010-2-032 or BS EN 61010-2-032, Pollution degree 2, 600 V CAT IV, 1000 V CAT III	

Table 16

Note: Currents < 0.05% of the nominal range will be set to zero.
The nominal ranges are reduced to 50/200/1000/5000 AAC at 400 Hz.

e) MN93 clamp

MN93 clamp		
Nominal Range	200 AAC for $f \leq 1$ kHz	
Measurement Range	0.5 to 240 AAC max (I > 200 A not permanent)	
Maximum Clamping Diameter	20 mm	
Variation of the position of the conductor in the clamp	< 0,5%, at 50/60 Hz	
Adjacent conductor carrying alternating current	> 35 dB typical at 50/60 Hz	
Safety	IEC/EN 61010-2-032 or BS EN 61010-2-032, Pollution degree 2, 300 V CAT IV, 600 V CAT III	

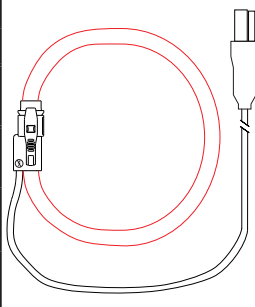
Table 17

Note: Currents < 100 mA will be set to zero.

f) MN93A clamp

MN93A clamp		
Nominal Range	5 A and 100 AAC	
Measurement Range	5 A: 0.01 to 6 AAC max; 100 A: 0.2 A to 120 AAC max	
Maximum Clamping Diameter	20 mm	
Variation of the position of the conductor in the clamp	< 0,5%, at 50/60 Hz	
Adjacent conductor carrying alternating current	> 35 dB typical at 50/60 Hz	
Safety	IEC/EN 61010-2-032 or BS EN 61010-2-032, Pollution degree 2, 300 V CAT IV, 600 V CAT III	

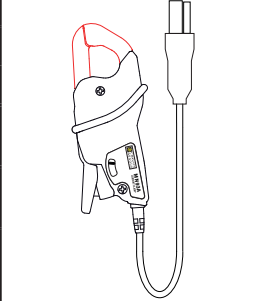
Table 18

The 5 A range of the MN93A is designed to work with secondary current transformers.

Note: Currents < 2.5 mA x ratio on the 5 A range and < 50 mA on the 100 A range will be set to zero with this probe.

g) MINI94 clamp

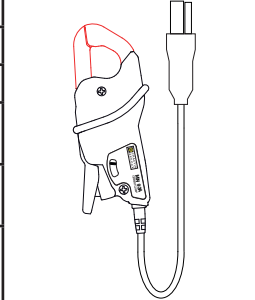
MINI94 clamp		
Nominal Range	200 Aac	
Measurement Range	50 mA to 200 Aac	
Maximum Clamping Diameter	16 mm	
Variation of the position of the conductor in the clamp	< 0,08%, at 50/60 Hz	
Adjacent conductor carrying alternating current	> 45 dB typical at 50/60 Hz	
Safety	IEC/EN 61010-2-032 ou BS/IEC/EN 61010-2-032, Pollution degree 2, 300 V CAT IV, 600 V CAT III	

Table 19

Note: Currents < 500 mA will be set to zero.

h) E94 clamp

E94 clamp		
Nominal Range	10 AAC/DC and 100 AAC/DC	
Measurement Range	10 A: 0.1 to 10 Apeak 100 A: 0.5 to 100 Apeak	
Maximum Clamping Diameter	11.8 mm	
Variation of the position of the conductor in the clamp	< 0,5%	
Adjacent conductor carrying alternating current	> 33 dB typical, from DC to 1kHz	
Safety	IEC/EN 61010-2-032 or BS EN 61010-2-032, Pollution degree 2, 300 V CAT IV, 600 V CAT III	

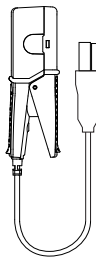
Table 20

Note: Currents < 50 mA will be set to zero in AC distribution systems.

i) J93 clamp

J93 clamp		
Nominal Range	3500 Aac, 5000 Adc	
Measurement Range	50 to 3500 Aac; 50 to 5000 Adc	
Maximum Clamping Diameter	72 mm	
Variation of the position of the conductor in the clamp	< ± 2%	
Adjacent conductor carrying alternating current	> 35 dB typical, from DC to 2 kHz	
Safety	IEC/EN 61010-2-032 or BS EN 61010-2-032, Pollution degree 2, 600 V CAT IV, 1000 V CAT III	

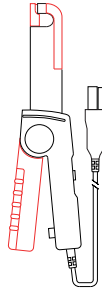
Table 21

Note: Currents < 5 A will be set to zero in AC distribution systems.

j) 5A adapter box/Essailec® adapter

5 A adapter box / Essailec® adapter	
Nominal Range	5 AAC
Measurement Range	0.005 to 6 AAC
Number of transformer inputs	3
Safety	IEC/EN 61010-2-030 or BS EN 61010-2-030, Pollution degree 2, 300 V CAT III

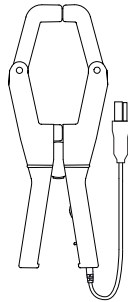
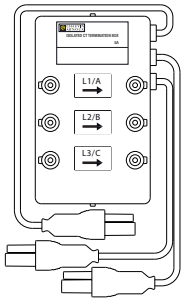

Table 22

Note: Currents < 2.5 mA will be set to zero.

6.2.4.3. Intrinsic uncertainty



The intrinsic uncertainties of the current and phase measured by the sensor must be added to the intrinsic uncertainties of the instrument for the quantity concerned (power, energy, power factor, $\tan \Phi$, etc.).

The following specifications are considered to be in the conditions of references of the current sensor.

Current sensors with 1 V output at I_{nom} specifications

Sensor type	I nominal	Current (RMS or DC)	Intrinsic uncertainty at 50/60 Hz	Intrinsic uncertainty on ϕ at 50/60 Hz	Typical uncertainty on ϕ at 50/60 Hz	Typical uncertainty on ϕ at 400 Hz
PAC93 clamp	1000 AAC 1300 ADC	[1 A; 50 A[$\pm 1.5\%R \pm 1 A$	-	-	- 4.5°@ 100 A
		[50 A; 100 A[$\pm 1.5\%R \pm 1 A$	$\pm 2.5^\circ$	- 0.9°	
		[100 A; 800 A[$\pm 2.5\%R$	$\pm 2^\circ$	- 0.8°	
		[800 A; 1000 A[$\pm 4\%R$		- 0.65°	
C193 clamp	1000 AAC	[1 A; 50 A[$\pm 1\%R$	-	-	+ 0.1°@ 1000 A
		[50 A; 100 A[$\pm 0.5\%R$	$\pm 1^\circ$	+ 0.25°	
		[100 A; 1200 A[$\pm 0.3\%R$	$\pm 0.7^\circ$	+ 0.2°	
MN93 clamp	200 AAC	[0,5 A; 5 A[$\pm 3\%R \pm 1 A$	-	-	-
		[5 A; 40 A[$\pm 2.5\%R \pm 1 A$	$\pm 5^\circ$	+ 2°	- 1.5°@ 40 A
		[40 A; 100 A[$\pm 2\%R \pm 1 A$	$\pm 3^\circ$	+ 1.2°	- 0.8°@ 100 A
		[100 A; 240 A[$\pm 1\%R + 1 A$	$\pm 2.5^\circ$	$\pm 0.8^\circ$	- 1°@ 200 A
MN93A clamp	100 AAC	[200 mA; 5 A[$\pm 1\%R \pm 2 mA$	$\pm 4^\circ$	-	-
		[5 A; 120 A[$\pm 1\%R$	$\pm 2.5^\circ$	+ 0.75°	- 0.5°@100 A
	5 AAC	[5 mA; 250 mA[$\pm 1.5\%R \pm 0,1 mA$	-	-	-
		[255 mA; 6 A[$\pm 1\%R$	$\pm 5^\circ$	+ 1.7°	- 0.5°@ 5 A
E94 clamp	100 AAC/DC	[5 A; 40 A[$\pm 4\%R \pm 50 mA$	$\pm 1^\circ$	-	-
		[40 A; 100 A[$\pm 15\%R$	$\pm 1^\circ$	-	-
	10 AAC/DC	[100 mA; 10 A[$\pm 3\%R \pm 50 mA$	$\pm 1.5^\circ$	-	-
MINI94 clamp	200 AAC	[0.05 A; 10 A]	$\pm 0.2\%R \pm 20 mA$	$\pm 1^\circ$	$\pm 0.2^\circ$	-
		[10 A; 240 A]		$\pm 0.2^\circ$	$\pm 0.1^\circ$	-
J93 clamp	3500 AAC 5000 ADC	[50 A; 100 A[$\pm 2\%R \pm 2.5 A$	$\pm 4^\circ$	-	-
		[100 A; 500 A[$\pm 1.5\%R \pm 2.5 A$	$\pm 2^\circ$	-	-
		[500 A; 3500 A[$\pm 1\%R$	$\pm 1.5^\circ$	-	-
]3500 ADC; 5000 ADC[$\pm 1\%R$	-	-	-
5A / Essailec® Adapter	5 AAC	[5 mA; 250 mA[$\pm 0.5\%R \pm 2 mA$	$\pm 0.5^\circ$	-	-
		[250 mA; 6 A[$\pm 0.5\%R \pm 1 mA$	$\pm 0.5^\circ$		

Table 23

AmpFlex® and MiniFlex specifications

Sensor type	I nominal	Current (RMS or DC)	Typical intrinsic uncertainty at 50/60 Hz	Intrinsic uncertainty at 400 Hz	Intrinsic uncertainty on φ at 50/60 Hz	Typical uncertainty on φ at 400 Hz
AmpFlex® A193	100 AAC	[200 mA; 5 A]	± 1.2 %R ± 50 mA	± 2 %R ± 0,1 A	-	-
		[5 A; 120 A] *	± 1.2 %R ± 50 mA	± 2 %R ± 0,1 A	± 0.5°	- 0.5°
	400 AAC	[0,8 A; 20 A]	± 1.2 %R ± 0.2 A	± 2 %R ± 0,4 A	-	-
		[20 A; 500 A] *	± 1.2 %R ± 0.2 A	± 2 %R ± 0,4 A	± 0.5°	- 0.5°
	2000 AAC	[4 A; 100 A]	± 1.2 %R ± 1 A	± 2 %R ± 2 A	-	-
		[100 A; 2400 A] *	± 1.2 %R ± 1 A	± 2 %R ± 2 A	± 0.5°	- 0.5°
10,000 AAC	[20 A; 500 A]	± 1.2 %R ± 5 A	± 2 %R ± 10 A	-	-	
	[500 A; 12000 A] *	± 1.2 %R ± 5 A	± 2 %R ± 10 A	± 0.5°	- 0.5°	
MiniFlex MA194	100 AAC	[200 mA; 5 A]	± 1 %R ± 50 mA	± 2 %R ± 0,1 A	-	-
		[5 A; 120 A] *	± 1 %R ± 50 mA	± 2 %R ± 0,1 A	± 0.5°	- 0.5°
	400 AAC	[0,8 A; 20 A]	± 1 %R ± 0.2 A	± 2 %R ± 0,4 A	-	-
		[20 A; 500 A] *	± 1 %R ± 0.2 A	± 2 %R ± 0,4 A	± 0.5°	- 0.5°
	2000 AAC	[4 A; 100 A]	± 1 %R ± 1 A	± 2 %R ± 2 A	-	-
		[100 A; 2,400 A] *	± 1 %R ± 1 A	± 2 %R ± 2 A	± 0.5°	- 0.5°
10,000 AAC (MA194) ¹	[20 A; 500 A]	± 1.2 %R ± 5 A	± 2 %R ± 10 A	-	-	
	[500 A; 12 000 A] *	± 1.2 %R ± 5 A	± 2 %R ± 10 A	± 0,5°	- 0,5°	

Table 24

1: Provided that the conductor can be clamped.



The nominal ranges are divided 8 by at 400Hz (*).

Limits of the AmpFlex® and MiniFlex

Like all Rogowski probes, the AmpFlex® and MiniFlex deliver output voltages proportional to the frequency. A high current at a high frequency can saturate the current inputs of the devices.

To avoid saturation, the following condition must be satisfied:

$$\sum_{n=1}^{n=\infty} [n \cdot I_n] < I_{nom}$$

Where I_{nom} is the range of the current sensor
 n is the order of the harmonic
 I_n is the current of the harmonic of order n

For example, the input current range of a dimmer must not exceed one fifth of the current range selected on the device.

This requirement does not take into account the limitation of the pass band of the device, which may lead to other errors.

6.3. COMMUNICATION

6.3.1. USB

Type B connector
USB 2

6.3.2. NETWORK

RJ45 connector with 2 built-in LEDs
100 Base T Ethernet

6.3.3. WI-FI

2.4 GHz band, IEEE 802.11 B/G/N radio
TX power: +17 dBm
RX sensitivity: -97 dBm
Rate: 72.2 MB/s max
Safety: WPA / WPA2
Access Point (AP): up to five clients

6.4. POWER SUPPLY

AC power (external power supply)

- Operating Range: 110 V - 250V @ 50/60/400 Hz
- Max Power: 30 VA

Battery

- Type: Rechargeable NiMH battery
- Battery mass: about 85 g
- Charge Time: 5 hours approx
- Recharging Temperature: 0° to 40°C (32 to 104°F)



When the instrument is off, the real-time clock is saved for more than 2 weeks.

Autonomy

- 30 minutes typical with no Wi-Fi

6.5. MECHANICAL SPECIFICATIONS

- **Dimensions:** 256 x 125 x 37 mm
- **Mass:** approximately 930 g
- **Drop Test:** 2 m in the most severe position without permanent mechanical damage or functional deterioration
- **Degrees of protection:** provided by enclosure (IP code) according to IEC 60529
 - IP 54 instrument not connected (de-energised)
 - IP20 instrument connected (operating)

6.6. ENVIRONMENTAL CHARACTERISTICS

- Indoor use.
- **Altitude**
 - Operation: 0 to 2,000 m
 - Storage: 0 to 10,000 m
- **Temperature and relative humidity**

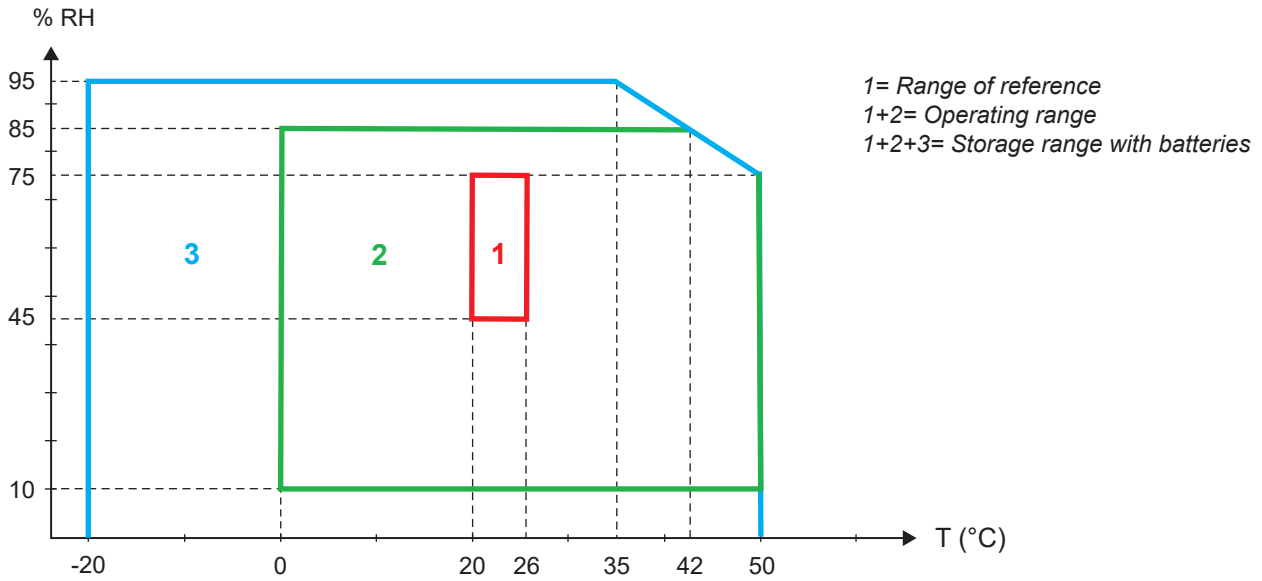

Figure 36

6.7. SAFETY SPECIFICATIONS

The instrument complies with IEC/EN 61010-2-030 for the following:

- Measurement inputs and enclosure: 600 V measurement category IV / 1000 V measurement category III, pollution degree 2
- Power supply: 600 V overvoltage category III pollution degree 2

The devices comply with EN 62479 and BS EN 62479 standards for EMF (Electromagnetic Field). Product intended for use by workers.

For the current sensors, see § 6.2.4

The current sensors comply with IEC/EN 61010-2-032.

The test leads and crocodile clips comply with IEC/EN 61010-031.

6.8. ELECTROMAGNETIC COMPATIBILITY

Emissions and immunity in an industrial setting compliant with IEC/EN 61326-1.

With the AmpFlex® and the MiniFlex, the typical influence on the measurement is 0.5% of full scale, with a maximum of 5A.

6.9. RADIO EMISSION

The devices are compliant with the 2014/53/EU RED directive and FCC Regulations.

Wi-Fi : FCC certification QQQWF121

6.10. MEMORY CARD

The PEL accepts FAT32-formatted SD, SDHC and SDXC cards up to a capacity of 32GB. The SDXC cards must be formatted in the instrument.

Number of insertions and withdrawals: 1,000.

The transfer of a large quantity of data may take a long time. Moreover, some computers may have difficulty processing such large quantities of information, and spread sheets accept only a limited quantity of data.

We recommend optimizing the data on the SD card and recording only the necessary measurements. For guidance, a 5-day record, with an aggregation time of 15 minutes, a record of the “1s” data and the harmonics on a three-phase four-wire network occupies approximately 530MB. If the harmonics are not essential and if recording of them is deactivated, the size is reduced to approximately 67MB.

The maximum durations of records for a 2GB card are the following:

- 7 days for recording with an aggregation time of 1 minute, the “1s” data, and the harmonics;
- 1 month for recording with an aggregation time of 1 minute, the “1s” data, but no harmonics;
- 1 year for recording with an aggregation time of 1 minute.

Do not exceed 32 records on the SD card.

For records that are long (duration greater than one week) or include the harmonics, use class 4 or higher SDHC cards.

Do not use the Wi-fi link to upload large records: it would take too long. If no other link is possible, shrink the record by removing the “1s” data and the harmonics. Without these last, a 30-day record occupies only 2.5MB.

On the other hand, uploading by USB or Ethernet link can be acceptable, depending on the length of the record and the transmission rate.

To transfer the data more rapidly, use the SD card/USB adapter.

7. MAINTENANCE



The instrument contains no parts that can be replaced by personnel who have not been specially trained and accredited. Any unauthorized repair or replacement of a part by an "equivalent" may gravely impair safety.

7.1. CLEANING



Disconnect the instrument from any source of electricity.

Use a soft cloth, dampened with soapy water. Rinse with a damp cloth and dry rapidly with a dry cloth or forced air. Do not use alcohol, solvents, or hydrocarbons.

Do not use the instrument if the terminals or keyboard are wet. Dry it first.

For the current sensors:

- Make sure that no foreign body interferes with the operation of the snap device of the sensor.
- Keep the clamp jaws as clean as possible. Do not splash water directly on the clamp

7.2. BATTERY

Your instrument is equipped with an NiMH battery. This technology offers several advantages:

- Long battery charge life for a limited volume and weight.
- Significantly reduced memory effect: you can recharge your battery even if it is not fully discharged.
- Respect for the environment: no pollutant materials such as lead or cadmium, in compliance with the applicable regulations.

After prolonged storage, the battery may be completely discharged. If so, it must be completely recharged. Your instrument may be unable to function during part of this recharging operation. Full recharging of a completely discharged battery may take several hours.



In this case, at least 5 charge/discharge cycles will be necessary for your battery to recover 95% of its capacity.

To make the best possible use of your battery and extend its effective service life:

- Only charge your instrument at temperatures between 0 and 40°C (32 and 104°F).
- Comply with the conditions of use.
- Comply with the storage conditions.

7.3. UPDATING THE SOFTWARE

With a view to providing, at all times, the best possible service in terms of performance and technical upgrades, Chauvin Arnoux invites you to update the embedded software of the device (firmware) and the application software (PEL Transfer).

7.3.1. UPDATING THE FIRMWARE

When your device is connected to PEL Transfer, you are informed that a new version of the software is available.

To update the firmware:

- Connect the device via USB, because the volume of data is too large for the other types of connection.
- Start the update.



Updating the embedded software may reset the configuration and causes the loss of the stored data. As a precaution, save the stored data to a PC before updating the embedded software.

7.3.2. UPDATING PEL TRANSFER

When started up, PEL Transfer checks that you have the latest version. If not, it invites you to upgrade.

You can also download upgrades from our site:

www.chauvin-arnoux.com

Go to "Support", then search on "**PEL112** or **PEL113**".

8. WARRANTY

Except as otherwise stated, our warranty is valid for **24 months** starting from the date on which the equipment was sold. The extract from our General Conditions of Sale is available on our website.

www.group.chauvin-arnoux.com/en/general-terms-of-sale

The warranty does not apply in the following cases:

- Inappropriate use of the equipment or use with incompatible equipment;
- Modifications made to the equipment without the explicit permission of the manufacturer's technical staff;
- Work done on the device by a person not approved by the manufacturer;
- Adaptation to a particular application not anticipated in the definition of the equipment or not indicated in the user's manual;
- Damage caused by shocks, falls, or floods.

9. APPENDIX

9.1. MEASUREMENTS

9.1.1. DEFINITION

Geometric representation of active and reactive power:

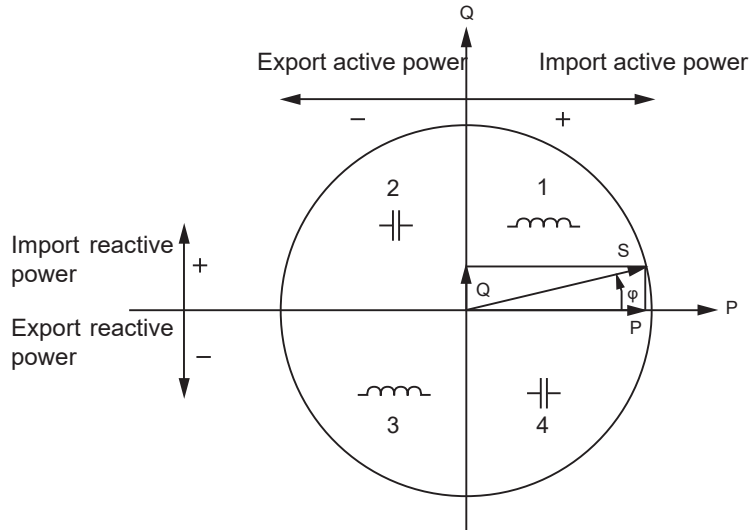

Figure 37

Diagram in accordance with appendix B of IEC 62053-24.

The reference of this diagram is the current vector (fixed on the right-hand part of the axis).

The voltage vector V changes its direction according to phase angle ϕ .

The phase angle ϕ between voltage V and current I is taken to be positive in the counterclockwise sense.

9.1.2. SAMPLING

9.1.2.1. Sampling Period

Depends on mains frequency: 50 Hz, 60 Hz or 400 Hz.

The sampling period is calculated every second.

- Mains frequency $f = 50$ Hz
 - From 42.5 to 57.5 Hz (50 Hz $\pm 15\%$), the sampling period is locked to the mains frequency. 128 samples are available for each mains cycle.
 - Outside the range 42.5 to 57.5 Hz, the sampling period is 128*50 Hz.
- Mains frequency $f = 60$ Hz
 - From 51 to 69 Hz (60 Hz $\pm 15\%$), the sampling period is locked to the mains frequency. 128 samples are available for each mains cycle.
 - Outside the range 51 to 69 Hz, the sampling period is 128*60 Hz.
- Mains frequency $f = 400$ Hz
 - From 340 to 460 Hz (400 Hz $\pm 15\%$), the sampling period is locked to the mains frequency. 16 samples are available for each mains cycle.
 - Outside the range 340 to 460 Hz, the sampling period is 16*400 Hz.

A pure DC measured signal is considered to be outside the frequency ranges. The sampling frequency is then, according to the preselected mains frequency, 6.4 kHz (50/400 Hz) or 7.68 kHz (60 Hz).

9.1.2.2. Locking of Sampling Frequency

- By default, the sampling frequency is locked to V1
- If V1 is missing, the sampling frequency attempts to lock to V2, then V3, I1, I2 and I3

9.1.2.3. AC/DC

The PEL makes AC and DC measurements for alternating current and direct current distribution systems. Selection of AC or DC is by the user.

AC +DC values are not available with PEL.

9.1.2.4. Measurement of Neutral Current

The PEL calculate the neutral current according to the distribution system.

9.1.2.5. "200ms" quantities

The instrument calculates the following quantities every 200 ms on the basis of measurements on 10 periods for 50Hz, 12 periods for 60Hz, and 80 periods for 400Hz, as indicated by Table 22.

The "200ms" quantities are used for:

- the trends on the "1s" quantities
- the aggregation of the values for the "1s" quantities (See § 9.1.2.6).

All of the "200ms" quantities can be recorded on the SD card during the recording session.

9.1.2.6. "1-second" Quantities

The instrument calculates the following quantities every second, according to § 9.2.

"1-second" quantities are used for:

- Real-time values
- "1-second" trends
- Aggregation of values for "aggregated" trends (see § 9.1.2.7)
- Min and max determination for "aggregated" trends

All "1 second" quantities are saved on the SD-Card during the recording time.

9.1.2.7. Aggregation

An aggregated quantity is a value calculated for a defined period, according to the formulas specified in Table 26.

Aggregation periods always start on rounded hours/minutes. The aggregation period is the same for all quantities. The period is one of the following: 1, 2, 3, 4, 5, 6, 10, 12, 15, 20, 30 and 60mn.

All aggregated quantities are saved on the SD-Card during the recording session. They can be displayed in the PEL Transfer.

9.1.2.8. Min and Max

Min and Max are the minimum and maximum values of the "1-second" quantities for the considered aggregation period in question. They are saved with the date and time of the Min and Max (see Table 26 for the available values). The Max aggregated values of some quantities are displayed directly.

9.1.2.9. Energy calculations

Energies are calculated every second.

The "Total" energy is the demand during the recording session.

The "Partial" energy can be determined during an integration period with the following values: 1 h, 1 day, 1 week, 1 month. The partial energy index is available only in real-time. It is not recorded.

However, the "Total" energy is available with the recording session data.

9.2. MEASUREMENT FORMULAS

PEL measures 128 samples per cycle (16 samples per f=400 Hz) and calculates the voltage, current and active power quantities over one cycle.

The PEL then calculates a value aggregated over 10 cycles (50Hz), 12 cycles (60Hz), or 80 cycles (400Hz). These are the “200 ms” quantities.

Then it calculates the values aggregated over 50 cycles (50Hz), 60 cycles (60Hz), or 400 cycles (400Hz). These are the “1 s” quantities.

Quantities	Formula	Comments
AC RMS phase-to-neutral voltage (V_L)	$V_L[1s] = \sqrt{\frac{1}{N} \times \sum_1^N v_L^2}$	$v_L = v_1, v_2$ or v_3 elementary sample N = Number of samples
DC voltage (V_L)	$V_L[1s] = \frac{1}{N} \times \sum_1^N v_L$	L = v_1, v_2 or v_3 elementary sample N = Number of samples
AC RMS phase-to-phase voltage (U_L)	$U_{ab}[1s] = \sqrt{\frac{1}{N} \times \sum_1^N u_{ab}^2}$	ab = u_{12}, u_{23} or u_{31} elementary sample N = Number of samples
AC RMS Current (I_L)	$I_L[1s] = \sqrt{\frac{1}{N} \times \sum_1^N i_L^2}$	$i_L = i_1, i_2$ or i_3 elementary sample N = Number of samples
DC Current (I_L)	$I_L[1s] = \frac{1}{N} \times \sum_1^N i_L$	$i_L = i_1, i_2$ or i_3 elementary sample N = Number of samples
Voltage crest factor (V-CF)	$V_{L-CF}[1s] = \frac{1}{n} \times \sum_{s=1}^n V_{L-CF_s}[1s]$	CF_{V_L} is the ratio of average crest values to the RMS value
Current crest factor (I-CF)	$I_{L-CF}[1s] = \frac{1}{n} \times \sum_{s=1}^n I_{L-CF_s}[1s]$	CF_{I_L} is the ratio of average crest values to the RMS value
Unbalance (u_2) real-time only	$u_2[1s] = 100 \times \frac{V^- [1s]}{V^+ [1s]}$	
Active Power (P_L)	$P_L[1s] = \frac{1}{N} \times \sum_1^N (v_L \times i_L)$	L = I1, I2 or I3 elementary sample N = Number of samples $P_T[1s] = P_1[1s] + P_2[1s] + P_3[1s]$
Reactive Power (Q_L)	$Q_L = V_{L-H1} \times I_{L-H1} \times \sin \phi(I_{L-H1}, V_{L-H1})$ $Q_T = Q_1 + Q_2 + Q_3$	Reactive power does not include harmonics. L = 1, 2 or 3
Apparent Power (S_L)	$S_L[1s] = V_L[1s] \times I_L[1s]$	
	$S_T[1s] = S_1[1s] + S_2[1s] + S_3[1s]$	The total apparent power $S_T[1s]$ is an arithmetic value
Power Factor (PF_L)	$PF_L[1s] = \frac{P_L[1s]}{S_L[1s]}$	
Cos ϕ_L	$\text{Cos } \phi_L[1s] = \text{Cos } \phi(I_{L-H1}, V_{L-H1})[1s]$	$\text{Cos } \phi_L$ is the cosine of the difference between the phase of the fundamental of the current I and the phase of the fundamental of the phase-to-neutral voltage V
Tan Φ	$\text{Tan } \Phi[1s] = \frac{Q_T[1s]}{P_T[1s]}$	
Fundamental angles $\phi(I_L, V_L)$ $\phi(I_L, I_M)$ $\phi(I_M, V_M)$	FFT calculation	ϕ is the phase difference between the fundamental current I_L and the fundamental voltage V_L
AC fundamental active power (Pf_L)	$Pf_L = V_{L-H1} \times I_{L-H1} \times \cos \phi(I_{L-H1}, V_{L-H1})$ $Pf_T = Pf_1 + Pf_2 + Pf_3$	L = 1, 2 or 3
AC fundamental direct active power (P^+)	$P^+ = 3 \times V^+ \times I^+ \times \cos \theta(I^+, V^+)$	
AC fundamental apparent power (Sf_L)	$Sf_L = V_{L-H1} \times I_{L-H1}$ $Sf_T = Sf_1 + Sf_2 + Sf_3$	L = 1, 2 or 3

Quantities	Formula	Comments
AC consumed active energy (E_{P+})	$E_{P+} = \sum P_{T+x}$	
AC generated active energy (E_{P-})	$E_{P-} = (-1) \times \sum P_{T-x}$	
AC reactive energy in quadrant 1 (E_{Q1})	$E_{Q1} = \sum Q_{Tq1x}$	
AC reactive energy in quadrant 2 (E_{Q2})	$E_{Q2} = \sum Q_{Tq2x}$	
AC reactive energy in quadrant 3 (E_{Q3})	$E_{Q3} = (-1) \times \sum Q_{Tq3x}$	
AC reactive energy in quadrant 4 (E_{Q4})	$E_{Q4} = (-1) \times \sum Q_{Tq4x}$	
AC consumed apparent energy (E_{S+})	$E_{S+} = \sum S_{T+x}$	
AC generated apparent energy (E_{S-})	$E_{S-} = \sum S_{T-x}$	
DC consumed energy ($E_{P_{dc+}}$)	$E_{P_{dc+}} = \sum P_{Tdc+x}$	
DC consumed energy ($E_{P_{dc-}}$)	$E_{P_{dc-}} = (-1) \times \sum P_{Tdc-x}$	
Phase-to-neutral voltage harmonic distortion rate THD_VL (%)	$THD_V=100 \times \sqrt{\frac{V_{eff}^2 - V_{H1}^2}{V_{H1}^2}}$	THD is calculated as % of fundamental VH1 is the value of the fundamental
Phase-to-phase voltage harmonic distortion level THD_Uab (%)	$THD_U=100 \times \sqrt{\frac{U_{eff}^2 - U_{H1}^2}{U_{H1}^2}}$	THD is calculated as % of fundamental UH1 is the value of the fundamental
Current harmonic distortion level THD_IL (%)	$THD_I=100 \times \sqrt{\frac{I_{eff}^2 - I_{H1}^2}{I_{H1}^2}}$	THD is calculated as % of fundamental IH1 is the value of the fundamental

Table 25

9.3. AGGREGATION

Aggregated quantities are calculated for a defined period according to the following formulas based on “1 second” values. They may be calculated by arithmetic or quadratic averaging, or other methods.

Quantities	Formula
Phase-to-neutral voltage (V_L) (RMS)	$V_L[agg] = \sqrt{\frac{1}{N} \times \sum_{x=0}^{N-1} V_{Lx}^2 [1s]}$
Phase-to-neutral voltage (V_L) (DC)	$V_L[agg] = \frac{1}{N} \times \sum_{x=0}^{N-1} V_{Lx} [200ms]$
Phase-to-phase voltage (U_{ab}) (RMS)	$U_{ab}[agg] = \sqrt{\frac{1}{N} \times \sum_{x=0}^{N-1} U_{abx}^2 [1s]}$ ab = 12, 23 or 31
Current (I_L) (RMS)	$I_L[agg] = \sqrt{\frac{1}{N} \times \sum_{x=0}^{N-1} I_{Lx}^2 [1s]}$

Quantities	Formula
Current (I_L) (DC)	$I_L[agg] = \frac{1}{N} \times \sum_{x=0}^{N-1} I_{Lx}[200ms]$
Voltage crest factor (CF_{VL})	$CF_{VL}[agg] = \frac{1}{N} \times \sum_{x=1}^N CF_{VL}[1s]$
Current crest factor (CF_{IL})	$CF_{IL}[agg] = \frac{1}{N} \times \sum_{x=1}^N CF_{IL}[1s]$
Unbalance (u_2)	$u_2[agg] = \frac{1}{N} \times \sum_{x=1}^N u_2[1s]$
Frequency (F)	$F[agg] = \frac{1}{N} \times \sum_{x=0}^{N-1} F_x[1s]$
Active Power exported (P_{SL})	$P_{SL}[agg] = \frac{1}{N} \times \sum_{x=0}^{N-1} P_{SLx}[1s]$
Active Power imported (P_{LL})	$P_{LL}[agg] = \frac{1}{N} \times \sum_{x=0}^{N-1} P_{LLx}[1s]$
Reactive Power exported (Q_{SL})	$Q_{SL}[agg] = \frac{1}{N} \times \sum_{x=0}^{N-1} Q_{SLx}[1s]$
Reactive Power imported (Q_{LL})	$Q_{LL}[agg] = \frac{1}{N} \times \sum_{x=0}^{N-1} Q_{LLx}[1s]$
Apparent Power (S_L)	$S_L[agg] = \frac{1}{N} \times \sum_{x=0}^{N-1} S_{Lx}[1s]$
Non-active power (N_L)	$N_L[agg] = \sqrt{S_L[agg]^2 - P_L[agg]^2}$ $L = 1, 2, 3 \text{ or } T$
Distortion power (D_L)	$D_L[agg] = \sqrt{N_L[agg]^2 - Q_L[agg]^2}$ $L = 1, 2, 3 \text{ or } T$
Export Power Factor (PF_{SL}) with associated quadrant	$PF_{SL}[agg] = \frac{1}{N} \times \sum_{x=0}^{N-1} PF_{SLx}[1s]$
Import Power Factor (PF_{LL}) with associated quadrant	$PF_{LL}[agg] = \frac{1}{N} \times \sum_{x=0}^{N-1} PF_{LLx}[1s]$
Cos (ϕ_L) _S at source with associated quadrant	$\text{Cos}(\phi_L)_S[agg] = \frac{1}{N} \times \sum_{x=0}^{N-1} \text{Cos}(\phi_L)_{Sx}[1s]$
Cos (ϕ_L) _L at load with associated quadrant	$\text{Cos}(\phi_L)_L[agg] = \frac{1}{N} \times \sum_{x=0}^{N-1} \text{Cos}(\phi_L)_{Lx}[1s]$
Tan Φ_S at source	$\text{Tan}(\phi)_S[agg] = \frac{1}{N} \times \sum_{x=0}^{N-1} \text{Tan}(\phi)_{Sx}[1s]$
Tan Φ_L at load	$\text{Tan}(\phi)_L[agg] = \frac{1}{N} \times \sum_{x=0}^{N-1} \text{Tan}(\phi)_{Lx}[1s]$
Phase-to-neutral voltage harmonic distortion level THD_{V_L} (%)	$THD_{V_L}[agg] = \frac{1}{N} \times \sum_{x=0}^{N-1} THD_{V_{Lx}}[1s]$
Phase-to-phase voltage harmonic distortion level $THD_{U_{ab}}$ (%)	$THD_{U_{ab}}[agg] = \frac{1}{N} \times \sum_{x=0}^{N-1} THD_{U_{abx}}[1s]$

Quantities	Formula
Current harmonic distortion level THD _{I_L} (%)	$THD_{I_L}[agg] = \frac{1}{N} \times \sum_{x=0}^{N-1} THD_{I_L} [1s]$

Table 26

Note: N is the number of “1 second” values for the considered aggregation period (1, 2, 3, 4, 5, 6, 10, 12, 15, 20, 30 or 60 min).

9.4. SUPPORTED ELECTRICAL NETWORKS

The following types of distribution systems are supported:

- V1, V2, V3 are the phase-to-neutral voltages of the installation under test [V1=VL1-N; V2=VL2-N; V3=VL3-N].
- Lower-case letters (v1, v2, v3) are used for sampled values
- U12, U23, U31 are the phase-to-phase voltages of the installation under test.
- Lower-case letters [u12 = v1-v2; u23= v2-v3, u31=v3-v1] are used for sampled values
- I1, I2, I3 are the currents flowing in the phase conductors of the installation under test.
- Lower-case letters i1, i2, i3 are used for sampled values

Distribution network	Abbreviation	Phase order	Remarks	Reference diagram
Single-phase (single-phase 2-wire)	1P- 2W	No	The voltage is measured between L1 and N. The current is measured on the L1 conductor.	See § 4.1.1.
Two-phase (split-phase single-phase 3-wire)	1P-3W	No	The voltage is measured between L1, L2 and N. The current is measured on the L1 and L2 conductors. The neutral current is measured or calculated: $i_N = i_1 + i_2$	See § 4.1.2.
Three-phase, 3-wire Δ [2 current sensors]	3P-3WΔ2	Yes	The power measurement method is based on the two-wattmeter method with a virtual neutral. The voltage is measured between L1, L2 and L3. The current is measured on the L1 and L3 conductors. The current I_2 is calculated (no current sensor on L2): $i_2 = -i_1 -i_3$ The neutral is not available for the measurement of the current and of the voltage	See § 4.1.3.1.
Three-phase, 3-wire open Δ (2 current sensors)	3P-3WO2			See § 4.1.3.3.
Three-phase 3-wire wye [2 current sensors]	3P-3WY2			See § 4.1.3.5.
Three-phase, 3-wire Δ (3 current sensors)	3P-3WΔ3	Yes	The power measurement is based on the three-wattmeter method with a virtual neutral. The voltage is measured between L1, L2 and L3. The current is measured on the L1, L2 and L3 conductors. The neutral is not available for the measurement of the current and of the voltage	See § 4.1.3.2.
Three-phase, 3-wire open Δ (3 current sensors)	3P-3WO3			See § 4.1.3.4.
Three-phase, 3-wire, wye [3 current sensors]	3P-3WY3			See § 4.1.3.6.
Three-phase, 3-wire Δ, balanced	3P-3WΔB	No	The power measurement is based on the one-wattmeter method. The voltage is measured between L1 and L2. The current is measured on the L3 conductor. $U_{23} = U_{31} = U_{12}$. $I_1 = I_2 = I_3$	See § 4.1.3.7.

Distribution network	Abbreviation	Phase order	Remarks	Reference diagram
Three-phase 4-wire wye	3P-4WY	Yes	The power measurement is based on the three-wattmeter method with neutral. The voltage is measured between L1, L2 and L3. The current is measured on the L1, L2 and L3 conductors. The neutral current is measured or calculated: $i_N = i_1 + i_2 + i_3$	See § 4.1.4.1.
Three-phase, 4-wire, wye, balanced	3P-4WYB	No	The power measurement is based on the one-wattmeter method. The voltage is measured between L1 and N. The current is measured on the L1 conductor. $V_1 = V_2 = V_3$ $U_{23} = U_{31} = U_{12} = V_1 \times \sqrt{3}$. $I_1 = I_2 = I_3$ $I_N = 3 \times I_1$	See § 4.1.4.2.
Three-phase, 4-wire, wye 2½	3P-4WY2	Yes	This method is called the 2½-element method The power measurement is based on the three-wattmeter method with a virtual neutral. The voltage is measured between L1, L3 and N. V2 is calculated: $v_2 = -v_1 - v_3$, $u_{12} = 2v_1 + v_3$, $u_{23} = -v_1 - 2v_3$. V2 is assumed to be balanced. The current is measured on the L1, L2 and L3 conductors. The neutral current is measured or calculated: $i_N = i_1 + i_2 + i_3$	See § 4.1.4.3.
Three-phase, 4-wire Δ	3P-4WΔ	No	The power measurement is based on the three-wattmeter method with neutral, but no power information is available for the individual phases. The voltage is measured between L1, L2 and L3. The current is measured on the L1, L2 and L3 conductors. The neutral current is measured or calculated for only one branch of the transformer: $i_N = i_1 + i_2 + i_3$	See § 4.1.5.1.
Three-phase, 4-wire, open Δ	3P-4WO			See § 4.1.5.2.
DC 2-wire	DC-2W	No	The voltage is measured between L1 and N. The current is measured on the L1 conductor.	See § 4.1.6.1.
DC 3-wire	DC-3W	No	The voltage is measured between L1, L2 and N. The current is measured on the L1 and L2 conductors. The negative (return) current is measured or calculated: $i_N = i_1 + i_2$	See § 4.1.6.2.
DC 4-wire	DC-4W	No	The voltage is measured between L1, L2, L3 and N. The current is measured on the L1, L2 and L3 conductors. The negative (return) current is measured or calculated: $i_N = i_1 + i_2 + i_3$.	See § 4.1.6.3.

Table 27

9.5. QUANTITY ACCORDING TO THE DISTRIBUTION NETWORK

= Yes = No

Quantities		1P-2W	1P-3W	3P-3WΔ2 3P-3WO2 3P-3WY2	3P-3WΔ3 3P-3WO3 3P-3WY3	3P-3WΔB	3P-4WY	3P-4WYB	3P-4WY2	3P-4WΔ 3P-4WO	DC-2W	DC-3W	DC-4W
V_1	AC RMS	•	•				•	•	•	•			
V_2	AC RMS		•				•	• = V_1	•(10)	•			
V_3	AC RMS						•	• = V_1	•	•			
V_1	DC										•	•	•
V_2	DC											•	•
V_3	DC												•

Quantities		1P-2W	1P-3W	3P-3W Δ 2 3P-3W Δ 3 3P-3W Δ B	3P-3W Δ 2 3P-3W Δ 3 3P-3W Δ B	3P-3W Δ B	3P-4WY	3P-4WYB	3P-4WY2	3P-4W Δ 3P-4W Δ O	DC-2W	DC-3W	DC-4W
V_1	AC + DC RMS	•	•				•	•	•	•			
V_2	AC + DC RMS		•				•	•(1)	•(10)	•			
V_3	AC + DC RMS						•	•(1)	•	•			
U_{12}	AC RMS		•	•	•	•	•	•(1)	•(10)	•			
U_{23}	AC RMS			•	•	•(1)	•	•(1)	•(10)	•			
U_{31}	AC RMS			•	•	•(1)	•	•(1)	•	•			
I_1	AC RMS	•	•	•	•	•	•	•	•	•			
I_2	AC RMS		•	•(2)	•	•(1)	•	•(1)	•	•			
I_3	AC RMS			•	•	•(1)	•	•(1)	•	•			
I_N	AC RMS		•				•(2)	•	•	•			
I_1	DC										•	•	•
I_2	DC											•	•
I_3	DC												•
I_N	DC											•	•
I_1	AC + DC RMS	•	•	•	•	•(1)	•	•	•	•			
I_2	AC + DC RMS		•	•(2)	•	•(1)	•	•(1)	•	•			
I_3	AC + DC RMS			•	•	•	•	•(1)	•	•			
I_N	AC + DC RMS		•				•	•	•	•			
V_{1-CF}		•	•				•	•	•	•			
V_{2-CF}			•				•	•(1)	•(10)	•			
V_{3-CF}							•	•(1)	•	•			
I_{1-CF}		•	•	•	•	•	•	•	•	•			
I_{2-CF}			•	•(2)	•	•(1)	•	•(1)	•	•			
I_{3-CF}				•	•	•(1)	•	•(1)	•	•			
V_+				•	•	•	•	•	•(10)				
V_-				•	•	•(4)	•	•(4)	•(10)				
V_0				•	•	•(4)	•	•(4)	•(10)				
I_+				•	•	•	•	•	•				
I_-				•	•	•(4)	•	•(4)	•				
I_0				•	•	•(4)	•	•(4)	•				
u_0				•	•	•(4)	•	•(4)	•(4)	•(3)			
u_2				•	•	•(4)	•	•(4)	•(4)	•(3)			
i_0				•	•	•(4)	•	•(4)	•	•(3)			
i_2				•	•	•(4)	•	•(4)	•	•(3)			
F		•	•	•	•	•	•	•	•	•			
P_1	AC	•	•				•	•	•	•			
P_2	AC		•				•	•(1)	•(10)	•			
P_3	AC						•	•(1)	•	•			
P_T	AC	•(7)	•	•	•	•	•	•(1)	•	•			
P_1	DC										•	•	•
P_2	DC											•	•
P_3	DC												•

Quantities		1P-2W	1P-3W	3P-3W Δ 2 3P-3W Δ 3 3P-3W Δ B	3P-3W Δ 2 3P-3W Δ 3 3P-3W Δ B	3P-3W Δ B	3P-4WY	3P-4WYB	3P-4WY2	3P-4W Δ 3P-4W Δ O	DC-2W	DC-3W	DC-4W
P_T	DC										●(7)	●	●
P_1	AC+DC	●	●				●	●	●	●			
P_2	AC+DC		●				●	●(1)	●(10)	●			
P_3	AC+DC						●	●(1)	●	●			
P_T	AC+DC	●(7)	●	●	●	●	●	●(1)	●	●			
Pf_1		●	●				●	●	●	●			
Pf_2			●				●	●(1)	●(10)	●			
Pf_3							●	●(1)	●	●			
Pf_T		●(7)	●	●	●	●	●	●(1)	●	●			
P_+				●	●	●	●	●(1)	●				
P_U				●	●	●(4)	●	●(4)	●				
P_h		●	●	●	●	●	●	●	●				
Q_1		●	●				●	●	●	●			
Q_2			●				●	●(1)	●(10)	●			
Q_3							●	●(1)	●	●			
Q_T		●(7)	●	●	●	●	●	●(1)	●	●			
S_1	AC	●	●				●	●	●	●			
S_2	AC		●				●	●(1)	●(10)	●			
S_3	AC						●	●(1)	●	●			
S_T	AC	●(7)	●	●	●	●	●	●(1)	●	●			
S_1	AC+DC	●	●				●	●	●	●			
S_2	AC+DC		●				●	●(1)	●(10)	●			
S_3	AC+DC						●	●(1)	●	●			
S_T	AC+DC	●(7)	●	●	●	●	●	●(1)	●	●			
Sf_1		●	●				●	●	●	●			
Sf_2			●				●	●(1)	●(10)	●			
Sf_3							●	●(1)	●	●			
Sf_T		●(7)	●	●	●	●	●	●(1)	●	●			
N_1	AC	●	●				●	●	●	●			
N_2	AC		●				●	●(1)	●(10)	●			
N_3	AC						●	●(1)	●	●			
N_T	AC	●(7)	●	●	●	●	●	●(1)	●	●			
D_1	AC	●	●				●	●	●	●			
D_2	AC		●				●	●(1)	●(10)	●			
D_3	AC						●	●(1)	●	●			
D_T	AC	●(7)	●	●	●	●	●	●(1)	●	●			
PF_1		●	●				●	●	●	●			
PF_2			●				●	●(1)	●(10)	●			
PF_3							●	●(1)	●	●			
PF_T		●(7)	●	●	●	●	●	●(1)	●	●			
$\text{Cos } \phi_1$		●	●				●	●	●	●			
$\text{Cos } \phi_2$			●				●	●(1)	●(10)	●			
$\text{Cos } \phi_3$							●	●(1)	●	●			
$\text{Cos } \phi_T$		●(7)	●	●	●	●	●	●(1)	●	●			
$\text{Tan } \Phi$		●	●	●	●	●(3)	●	●	●(10)	●			
$V_1\text{-Hi}$	i=1 at 50 (6) %f	●	●				●	●	●	●			
$V_2\text{-Hi}$			●				●	●(1)	●(10)	●			
$V_3\text{-Hi}$							●	●(1)	●	●			

Quantities		1P-2W	1P-3W	3P-3W Δ 2 3P-3W Δ 3 3P-3W Δ B	3P-3W Δ 2 3P-3W Δ 3 3P-3W Δ B	3P-3W Δ B	3P-4WY	3P-4WYB	3P-4WY2	3P-4W Δ 3P-4W Δ O	DC-2W	DC-3W	DC-4W
U ₁₂ -Hi	i=1 at 50 (6) %f		●	●	●	●	●	●(1)	●(10)	●			
U ₂₃ -Hi				●	●	●(1)	●	●(1)	●(10)	●			
U ₃₁ -Hi				●	●	●(1)	●	●(1)	●	●			
I ₁ -Hi	i=1 at 50 (6) %f	●	●	●	●	●	●	●	●	●			
I ₂ -Hi			●	●(2)	●	●(1)	●	●(1)	●	●			
I ₃ -Hi				●	●	●(1)	●	●(1)	●	●			
I _N -Hi			●(2)				●(2)	●(4)	●(2)	●(2)			
V ₁ -THD	%f	●	●				●	●	●	●			
V ₂ -THD	%f		●				●	●(1)	●(10)	●			
V ₃ -THD	%f						●	●(1)	●	●			
U ₁₂ -THD	%f		●	●	●	●	●	●(1)	●	●			
U ₂₃ -THD	%f			●	●	●(1)	●	●(1)	●	●			
U ₃₁ -THD	%f			●	●	●(1)	●	●(1)	●	●			
I ₁ -THD	%f	●	●	●	●	●	●	●	●	●			
I ₂ -THD	%f		●	●(2)	●	●(1)	●	●(1)	●	●			
I ₃ -THD	%f			●	●	●(1)	●	●(1)	●	●			
I _N -THD	%f		●(2)				●(2)	●(4)	●(2)	●(2)			
Phase order	I			●	●	●	●		●	●			
	V			●	●	●	●		●	●			
	I, V	●	●	●	●	●	●	●	●	●			
$\varphi(V_2, V_1)$		●				●	●(9)						
$\varphi(V_3, V_2)$						●	●(9)						
$\varphi(V_1, V_3)$						●	●(9)	●	●				
$\varphi(U_{23}, U_{12})$				●	●	●(9)	●	●(9)		●			
$\varphi(U_{12}, U_{31})$				●	●	●(9)	●	●(9)		●			
$\varphi(U_{31}, U_{23})$				●	●	●(9)	●	●(9)		●			
$\varphi(I_2, I_1)$			●		●	●(9)	●	●(9)	●	●			
$\varphi(I_3, I_2)$					●	●(9)	●	●(9)	●	●			
$\varphi(I_1, I_3)$				●	●	●(9)	●	●(9)	●	●			
$\varphi(I_1, V_1)$		●	●			●(8)	●	●	●	●			
$\varphi(I_2, V_2)$			●				●	●					
$\varphi(I_3, V_3)$							●	●	●	●			
E _{PT}	Source AC	●	●	●	●	●	●	●	●	●	●(5)	●(5)	●(5)
E _{PT}	Load AC	●	●	●	●	●	●	●	●	●	●(5)	●(5)	●(5)
E _{QT}	Quad 1	●	●	●	●	●	●	●	●	●	●(5)	●(5)	●(5)
E _{QT}	Quad 2	●	●	●	●	●	●	●	●	●	●(5)	●(5)	●(5)
E _{QT}	Quad 3	●	●	●	●	●	●	●	●	●	●(5)	●(5)	●(5)
E _{QT}	Quad 4	●	●	●	●	●	●	●	●	●	●(5)	●(5)	●(5)
E _{ST}	Source	●	●	●	●	●	●	●	●	●	●(5)	●(5)	●(5)
E _{ST}	Load	●	●	●	●	●	●	●	●	●	●(5)	●(5)	●(5)
E _{PT}	Source DC	●(5)	●(5)	●(5)	●(5)	●(5)	●(5)	●(5)	●(5)	●(5)	●	●	●
E _{PT}	Load DC	●(5)	●(5)	●(5)	●(5)	●(5)	●(5)	●(5)	●(5)	●(5)	●	●	●

Table 28

(1) Extrapolated

(2) Calculated

(3) Value not significant

(4) Always = 0

(5) AC+DC when selected

(6) 7th max at 400Hz

(7) $P_1 = P_T$, $\varphi_1 = \varphi_T$, $S_1 = S_T$, $PF_1 = PF_T$, $\cos \varphi_1 = \cos \varphi_T$, $Q_1 = Q_T$, $N_1 = N_T$, $D_1 = D_T$

- (8) $\varphi (I_3, U_{12})$
- (9) Always = 120°
- (10) Interpolated

9.6. GLOSSARY

φ	Phase shift of the phase-to-neutral voltage with respect to the phase-to-neutral current.
$\overset{+}{\parallel}$	Inductive phase shift.
$\overset{-}{\parallel}$	Capacitive phase shift.
°	Degree.
%	Percentage.
A	Ampère (current unit).
AC	AC component (current or voltage).
Aggregation	Different averages defined in § 9.3.
APN	Access Point Name. This depends on your Internet access provider.
CF	Crest factor (Peak Factor) in current or voltage: ratio of the peak value of a signal to the RMS value.
cos φ	Cosine of the phase shift of the fundamental voltage with respect to the fundamental current.
D	Distortion power.
DC	DC component (current or voltage).
Ep	Abbreviation for active energy.
Eq	Abbreviation for reactive energy.
Es	Abbreviation for apparent energy.
Frequency	number of full voltage or current cycles in one second.
Fundamental component:	component at the fundamental frequency.
Harmonics	in electrical systems, voltages and currents at frequencies that are multiples of the fundamental frequency.
Hz	Frequency of the network.
I	Abbreviation for current.
I-CF	Crest (peak) factor of current
I-THD	Total harmonic distortion of current
Ix-Hh	Current value or percentage for harmonic order n.
IRD server (DataViewSync™):	Internet Relay Device serveur. Server used to relay data between the logger and a PC.
L	Phase of a polyphased electrical power network.
MAX	Maximum value.
Measurement method:	Any measurement method associated with an individual measurement.
MIN	Minimum value.
N	Non-active power.
Nominal voltage:	Reference voltage of a network.
Order of a harmonic:	ratio of the frequency of the harmonic to the fundamental frequency; a whole number.
P	Abbreviation for active power.
PF	Power Factor: ratio of active power to apparent power.
Phase	temporal relationship between current and voltage in alternating current circuits.
Q	Abbreviation for reactive power.
RMS	RMS (Root Mean Square) value of current or voltage. Square root of the mean of the squares of the instantaneous values of a quantity during a specified interval.
S	Abbreviation for apparent power.
tan Φ	Ratio of reactive power to active power.
THD	Total Harmonic Distortion. The total harmonic distortion describes the proportion of the harmonics of a signal with respect to the RMS value of the fundamental or to the total RMS value without DC.
U	Phase-to-phase voltage.
U-CF	Phase-to-phase voltage crest factor
u2	Phase-to-neutral voltage unbalance.
Ux-Hn	Phase-to-phase voltage (value or percentage) for harmonic order n.
Uxy-THD	Total phase-to-phase voltage harmonic distortion
V	Abbreviation for phase-to-neutral voltage or the unit “volt”.

- V-CF** Voltage crest (peak) factor
- VA** Apparent power unit (Volt-Ampere).
- var** Reactive power unit.
- varh** Reactive energy unit.
- V-THD** Total harmonic distortion of phase-to-neutral voltage.
- Voltage unbalance in a polyphased electrical power network:** State in which the RMS voltages between conductors (fundamental component) and/or the phase differences between successive conductors are not equal.
- Vx-Hn** Phase-to-neutral voltage (value or percentage) for harmonic order n.
- W** Active power unit (Watt).
- Wh** Active energy unit (Watt-hour).

Prefixes of International System (SI) units

Prefix	Symbol	Multiplies by
milli	m	10^{-3}
kilo	k	10^3
Mega	M	10^6
Giga	G	10^9
Tera	T	10^{12}
Peta	P	10^{15}
Exa	E	10^{18}

Table 29



FRANCE

Chauvin Arnoux

12-16 rue Sarah Bernhardt

92600 Asnières-sur-Seine

Tél : +33 1 44 85 44 85

Fax : +33 1 46 27 73 89

info@chauvin-arnoux.com

www.chauvin-arnoux.com

INTERNATIONAL

Chauvin Arnoux

Tél : +33 1 44 85 44 38

Fax : +33 1 46 27 95 69

Our international contacts

www.chauvin-arnoux.com/contacts

